



DATA SWITCH BOXES & ACTIVE DEVICES

SMART AUTO SWITCH BOXES

- Support Both Dot Matrix and Laser Printers

MNI-SAUTO-22P-1284	2 To 2 IEEE 1284 BI-TRONICS Printer Switch
MNI-SAUTO-41P-1284	4 To 1 IEEE 1284 BI-TRONICS Printer Switch
MNI-SAUTO-42P	4 To 2 Parallel Smart Switch



AUTO SWITCH BOXES

- Support Both Dot Matrix and Laser Printers
- Auto Scan for Signal
- Fully Signal Transparent

MNI-AUTO-25-8P

P=PARALLEL



SIGNAL BOOSTERS

- No External Power or Battery is needed
- Boost Signal over 500 ft to extend the range of your parallel or Serial printer.

ADL-SBP Parallel Booster

ADL-SBS Serial Booster



SIGNAL CONVERTERS

- Interchanges signals between Serial and Parallel Devices
- AC Adapter Included in some Converters
- Single Converter, Bi-directional P/S

ADL-PBIS-256

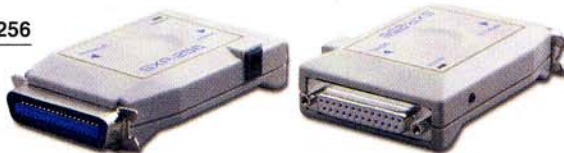

MEMORY CARD READER

- Compliant with USB Specification Version 2.0 & 1.1.
- USB 2.0, 9 in 1
- USB Bus Power
- High Speed Up to 480 Mbits/s.

MCR-9IN1USB2

- USB 2.0 SD/MMC.

MCR-U2MMCS



Color Varies



Styles and Models Subject to Change

D-SUB SWITCH BOXES

- Metal Casing, Fully Shielded, Rotary Switch or Push Button for Extended Use.
- All Female Connectors.
- Gold Plated Contacts Ensure Signal Integrity.

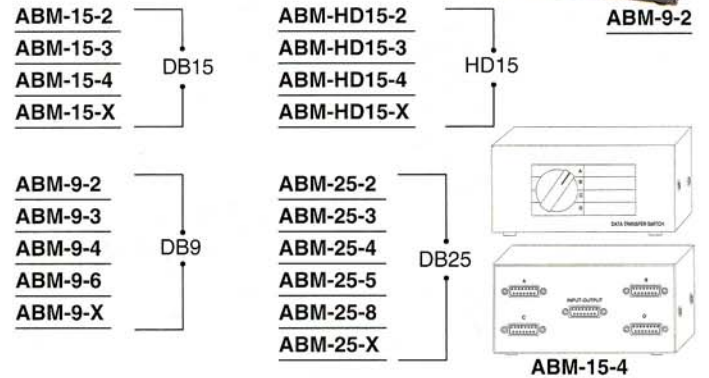

ABM-2536-2	DB25 in, 2 DB36 out
ABM-25W-2/3	2 Computer in 3 Printer out, or 3 computer in, 2 Printer out
ABM-3625-2	DB36 in, 2 DB 25 out
ABM-37-2	DB 37, 2 Positions
ABM-D50-2	DB 50, 2 Positions



X= Cross Over

MODULAR PRINTER NETWORK

- Allows up to 24 PCs share up to 8 Parallel Printers
- Automatic Printer Selection; Simultaneous Printing Capabilities
- Distance Up to 1200ft; Transmission Rate: 45Kbps
- Printer Selector Utilities included for both DOS and Windows
- Link Kit includes Two Transmitting Module and one Receiving Module.

ADL-LNKSET Include 1 receiver, 2 Transmitter, Utility Software, AC/DC Adaptor, and 2 25ft Modular Line Cord

ADL-LNK-T Transmitter

ADL-LNK-R ReceiverReceiver



Styles and Models Subject to Change

DATA SWITCH BOXES

USB SWITCH BOXES

ABM-USB-2B 2B In, 1A Out

ABM-USB-4B 4B In, 1A Out

ABM-USB-2 2-Way

ABM-USB-4 4-Way



- Metal Casing, Fully Shielded, Rotary Switch or Push Button for Extended Use.
- All Female Connectors.
- Gold Plated Contacts Ensure Signal Integrity.

SPECIALTY SWITCH BOXES

ABM-D5-2
ABM-D5-3
ABM-D5-4 Din 5

ABM-MD4-2
ABM-MD4-3
ABM-MD4-4 Mini Din 4 Pin

ABM-BNC-2
ABM-BNC-3
ABM-BNC-4
ABM-BNC-X BNC Female

ABM-MD6-2
ABM-MD6-3
ABM-MD6-4 Mini Din 6 Pin

ABM-TWX-2 Twinax Female

ABM-MD8-2
ABM-MD8-3
ABM-MD8-4
ABM-MD8-X Mini Din 8 Pin

MONITOR, KEYBOARD, COMBO SWITCH BOXES

- Metal Casing, Fully Shielded, Rotary Switch or Push Button for Extended Use.
- Gold Plated Contacts Ensure Signal Integrity.
- All Female Connectors.

ABM-H15MD8-2

ABM-H15MD8-4

ABM-H15/5/9-2

ABM-H15/5/9-4

ABM-H15/9/MD6-2

ABM-H15/9/MD6-4

ABM-H15MD6/6-2

ABM-H15MD6/6-4

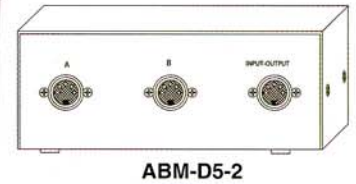
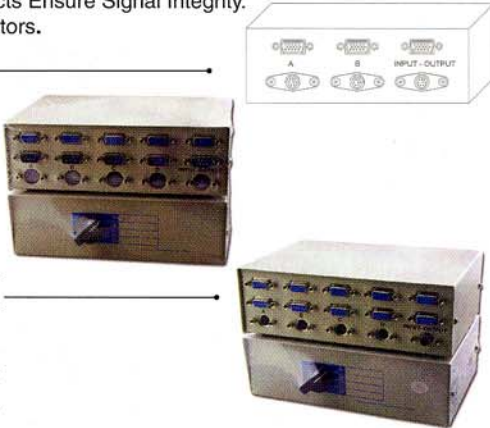

ABM-D5-2

ABM-MD6-4

Monochrome Monitor Switch DB9 Din5 Two Way

ABM-9X5D-2

VGA Monitor and AT Type Keyboard Switch

ABM-H15/5-2

ABM-H15/5-3

ABM-H15/5-4

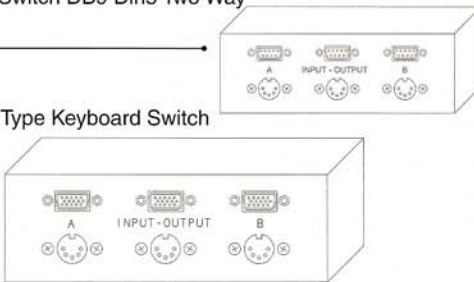

MODULAR SWITCH BOXES

ABM-T6-2
ABM-T6-3
ABM-T6-4
ABM-T6-X RJ11, 6C

ABM-T8-2
ABM-T8-3
ABM-T8-4
ABM-T8-X RJ45, 8C

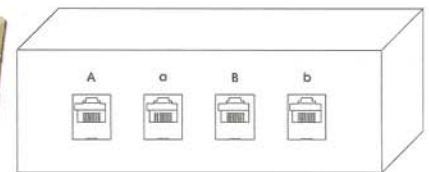

ABM-T6-2

ABM-T8-X

VGA Monitor and PS-2 Type Keyboard Switch Positions

ABM-H15MD6-2

ABM-H15MD6-3

ABM-H15MD6-4

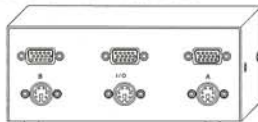

MINI BREAK OUT BOXES (Data Switch Boxes)

- 12 Circuit Monitor LEDs
- Access To all RS232/V24, RS232/V.35, RS232/X21 Circuit
- Pocket Size, w/ Jumpers Included.

MNI-BRKBOX Mini breakout box for RS232/DB25

MNI-MPS Mini Monitor Power Saver

BOB-V24 For V.24 interface, Rechargeable

BOB-V35 For V.35 Interface

BOB-X21 For X21 Interface



MNI-MPS

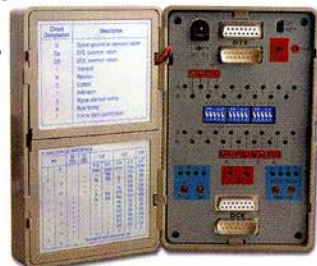

CENTRONIC SWITCH BOXES

ABM-36-2
ABM-36-3
ABM-36-4
ABM-36-X 36 Pin

ABM-C50-2
ABM-C50-4 50 Pin

ABM-IEEE488-2 → 24 Pin

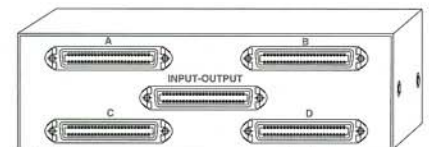

ABM-C50-4



 X= Cross Over