

3 PIECE DUAL CRIMP PLUG

- All Pre-Packed Pieces Sets, in Individual Bags.
- All Machined Type Brass w/ Nickel Over Plating Connectors Except BNC38xx - 78xx Series (with Die Cast Caps).
- Gold Plated Captive Contact Pins. Can be Crimped or Soldered.



PLUGS PART NO.	RG TYPE CABLE	REMARK
BNC-3021	RG-59/U, 62A/U	0.76mm (23 AWG)
BNC-3021-1.1	RG-59/U, 62A/U	1.1mm Pin Bore
BNC-3021-75	RG-59/U	75Ω
BNC-3021-7511	RG-59/U	75Ω 1.1mm Pin Bore
BNC-7021	RG-59/U, 62A/U	(23 AWG)
BNC-7021-7511	RG-59/U, 62A/U	75Ω 1.1mm Pin Bore
BNC-3821	RG-59/U, 62A/U	Die Cast (23 AWG)
BNC-7821	RG-59/U, 62A/U	Die Cast (23 AWG)
BNC-3022	RG-58/U	0.9mm (20 AWG)
BNC-3022-C	RG-58C/U	1.1mm Pin Bore
BNC-3022TH	RG-58 THIN NET	
BNC-3822	RG-58/U	Die Cast Cap
BNC-3822-C	RG-58C/U	Die Cast Cap
BNC-7022-A	RG-58C/U, 58A/U	
BNC-7822-A	RG-58A/U	Die Cast Cap
BNC-3023	RG-6/U	
BNC-3023-75	RG-6/U	75Ω
BNC-7023	RG-6/U	
BNC-3823	RG-6/U	Die Cast Cap
BNC-3024	RG-59/U Plenum	
BNC-3024-1.1	RG-59/U Plenum	1.1mm Pin Bore
BNC-3024-75	RG-59/U Plenum	75Ω, 22 AWG
BNC-3824	RG-59/U Plenum	Die Cast Cap
BNC-3025	RG-58/U Plenum	
BNC-3025-C	RG-58C/U Plenum	
BNC-3825	RG-58/U Plenum	Die Cast Cap
BNC-3026-75	Belden 8281	75Ω
BNC-3027	Belden 8218	
BNC-3027-75	Belden 8218	75Ω
BNC-3028	RG-174/U, 316/U	
BNC-7028	RG-174/U, 316/U	
BNC-3029-8X	Mini 8X Cable	
BNC-3029-11	RG-11	75Ω
BNC-3029-179-75	RG-179/U	75Ω, for 30 AWG
BNC-3029-196	RG-196/U	
BNC-3029-213	RG-8/U, 213/U	
BNC-3029-735A-75	735A	75Ω, for 26 AWG
BNC-7029-735A-75	735A	75Ω
BNC-3029-L400	9913, LMR400	

BULK PACKAGED DUAL CRIMP PLUGS

- Ideal for Large Quantity Orders.

Part No.	Package:
BNC-3021-BULK	Each Bulk Bag Contains Three Separate Bags. Each Separate Bags Contains 50 or 100pc each of Body, Ferrules or Pins.
BNC-3022-BULK	
BNC-3022-C-BULK	
BNC-3026-75-BULK	



DUAL FERRULE PACKS

- All Pre-Packed four Piece Sets, in Individual Poly Bags.
- Contains Both PVC and Plenum Size Ferrules.
- Gold Plated Captive Contact Pins.
- Die Cast Cap Type.

BNC-38214	For RG-59/U, 62/U
BNC-38214-1.1	For RG-59/U, 62/U, 1.1 mm Pin
BNC-38225A	For RG-58A/U, C/U
BNC-38239	For RG-6/U



DUAL CRIMP

- All Pre-packed 3 Pieces in Individual Poly Bags.
- Gold Plated Contact Pins.

Right Angle Plug

BNC-3041-75	For RG59/U, 62/U
BNC-3049-735A-75	For 735A Cable

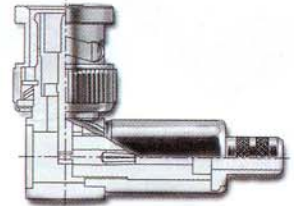

Jacks

BNC-3121	For RG-59/U, 62/U
BNC-3121-75	For RG-59/U, 75Ω
BNC-3121-7511	For RG-59, 75Ω, 1.1Pin
BNC-3122	For RG-58/U Cable
BNC-3122A	For RG-58A/U, C/U
BNC-3123-75	For RG-6, 75Ω
BNC-3127-75	For Belden-8218, 75Ω
BNC-3128	For RG-174/U, 316/U
BNC-3129-179-75	For RG-179/U, 75Ω



STANDARD CLAMP WITH SOLDER PINS

- All Pre-packed Individual Poly bag.
- All Machined Type Connectors.
- Gold Plated Contact Pins.

Plugs

BNC-3011	For RG-59/U, 62/U
BNC-3011-75	For RG-59/U, 75Ω
BNC-3012	For RG-58/U



Jacks

BNC-3151	For RG58
BNC-3152	For RG59



WEDGE COMPRESSION

- All Pre-packed Individual Poly bag.
- All Machined Type Connectors.
- Gold Plated Contact Pins.

BNC-3051	For RG-59/U, 62/U
BNC-3052	For RG-58/U



2 PIECE CRIMP

- All Pre-packed Two Piece Sets in Individual Poly bag.
- All **Machined Type** Connectors.
- Gold Plated Contact Pins.
- For Cables with Solid Center Conductor Only.

Plugs (Male)

BNC-3071	RG-59/U,62/U
BNC-3071-75	RG-59, 75Ω
BNC-3073-75	RG-6, 75Ω
BNC-3072	RG-58/U
BNC-3074-75	RG-59/U Plenum, 75Ω
BNC-3075	RG-58/U Plenum
BNC-7071	RG-59/U, 62/U
BNC-7071X	RG-59/U
BNC-7071X-75	RG-59/U, 75Ω
BNC-7071-75	RG-59, 75Ω
BNC-7072	RG-58/U
BNC-7072A	RG58A/U
BNC-7073T	RG-6/U Plenum
BNC-7073-75	RG-6, 75Ω
BNC-7074	RG-59/U Plenum
BNC-7075	RG58/U Plenum
BNC-7076-75	For Belden 8281, 75Ω



TWIST ON

- All Pre-packed Individual Poly bag.
- All Machined Type Connectors.
- Gold Plated Contact pins.
- Recommended for Cables with Solid Center Conductor Only.

Plugs (Male)

BNC-3031	For RG59/U, 62/U
BNC-7031	For RG59/U, 62/U
BNC-3032	For RG58/U
BNC-7032	For RG58/U
BNC-3033	For RG6/U
BNC-3034	For Plenum RG59/U, 62/U
BNC-3035	For Plenum RG58/U
BNC-3036	For Belden 8281



BNC-3031

Jacks (Female)

BNC-3131	For RG59/U, 62/U
BNC-3132	For RG58/U
BNC-3134	For Plenum RG59/U, 62/U
BNC-3135	For Plenum RG58/U
BNC-7136	For Belen 8281



BNC-3131

Jacks (Female)

BNC-7171	RG59/U, 62/U
BNC-7171-75	RG-59/U, 75Ω
BNC-7172	RG58/U
BNC-7172A	RG58A/U
BNC-7173	RG6/U
BNC-7174	RG59/U, 62/U Plenum
BNC-7176	RG6/U Plenum



BULKHEAD RECEPTACLE ISOLATED JACK

- Compatible w/ Amphenol 31-10.
- Rear Mount.
- 3/8" Diameter.



BNC-3199
BNC-3199-BULK

BULKHEAD DUAL CRIMP JACK

- All Pre-packed Individual Poly bag.
- Front Mount.
- Captive Gold Plated Center Contact.



BNC-3104 RG59/U, 62/U PVC
BNC-3105 RG58/U PVC

Y DUAL CRIMP PLUG

- For RG-58A/U, C/U.
- Gold Plated Center Pins.
- Set of 2 Pins and 2 Ferrules Included.

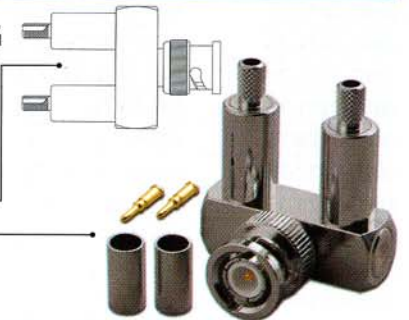

BNC-7066 180 Degree
BNC-7067 90 Degree

BULKHEAD JACKS

- Rear Mount.
- Solder Cup.
- Gold Plated Contact.



BNC-3194T	A=26.7mm, UG-1094/U, Teflon Insulator
BNC-3194-75	A=26.7mm, 75 Ω
BNC-7194	UG-1094/U, Delrin Insulator
BNC-7194T	UG-1094/U, Teflon Insulator
BNC-3894	Die Cast Body, A=26.7mm, UG-1034/U, Delrin Insulator
BNC-3195	A=30mm, UG-1094A/U, Delrin Insulator
BNC-3196	A=33mm, UG-1094B/U, Delrin Insulator

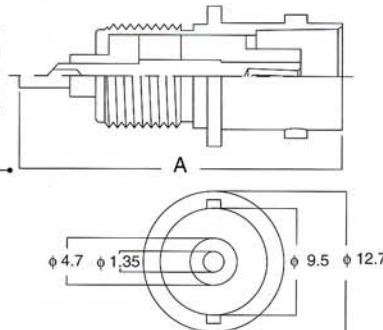

PANEL MOUNT JACK

- Solder Cup.
- Gold Plated Contact.
- Insulation Materials.

BNC-3197

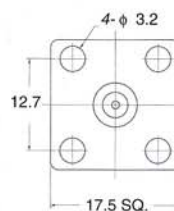

SNAP FIT

- Compression Type.
- Weather/Moisture Sealed After Assembly.
- Gold Plated Contact.

BNC-7071SN For RG-59
BNC-7073SN For RG-6
BNC-7074SN For RG-59 Quad-Shield
BNC-7079SN For RG-6 Quad-Shield

BNC-7071WS For 59/U, 62/U
BNC-7077WS For Mini 59 Coax Cable
BNC-7171WS For 59/U, 62/U

 See PG 80 for Crimp Tool



75 Ohm SERIES

 See PG 79 for Connector-Tool Reference

BNC-3011-75	RG-59/U, Standard Solder Clamp Plug
BNC-3021-75	RG-59/U, 3pc Crimp Plug
BNC-3021-7511	RG-59/U, 1.1 mm Pin, 3pc Crimp (Up To 18 AWG)
BNC-3023-75	RG-6/U, 3pc Crimp Plug
BNC-3024-75	RG-59/U Plenum, 3pc Crimp Plug
BNC-3026-75	Belden 8281, 3pc Crimp Plug
BNC-3027-75	Belden 8218, 3pc Crimp Plug
BNC-3029-11	RG-11, 3pc Crimp Plug
BNC-3029-179-75	RG-179/U, Dual Crimp Type, Plug
BNC-3029-735A-75	735A, Dual Crimp Type, Plug
BNC-3041-75	Right Angle, RG-59/U, Dual Crimp Plug
BNC-3062	Terminator, Male, 0.5W
BNC-3062-1	Terminator, Male, 0.5W, 1%
BNC-3062-2	Terminator, Male, W/chain, 0.5W, 1%
BNC-3071-75	RG-59, 2pc Plug
BNC-3073-75	RG-6, 2pc Plug
BNC-3074-75	RG-59/U, Plenum, 2pc Plug
BNC-3121-75	RG-59/U, 3pc Crimp Jack
BNC-3121-7511	RG-59, 3pc Crimp Jack, 18 AWG Pin
BNC-3123-75	RG-6, 3pc Crimp Jack
BNC-3127-75	Belden 8218, 3pc Crimp Jack
BNC-3129-179-75	RG-179/U, Dual Crimp Jack
BNC-3192-75	UG-492D/U, Bulkhead Feed Thru Jack
BNC-3193-75	Isolated UG-492D/U, Bulkhead Feed Thru Jack
BNC-3194-75	Solder Type, UG-1094D/U, Bulkhead Jack
BNC-3306-75	Adaptor, M-F Right Angle, 75Ω
BNC-3314-75	Adaptor, Female Inline Splice, UG-914/U
BNC-3374-75	"T" Adaptor, J-P-J , UG-274D/U
BNC-3375-75	"T" Adaptor, J-J-J
BNC-7001-D65	Assembly Type ID=6.5mm
BNC-7029-179-75	RG-179/U, Dual Crimp Type, 3pc Plug
BNC-7029-735A-75	For 735A, 3pc Plug 
BNC-7071-75	RG-59, 2pc Crimp Plug
BNC-7073-75	RG-6, 2pc Crimp Plug
BNC-7076-75	Belden 8281, 2pc. Crimp Plug
BNC-7077WS	Mini 59 Coax Compression Plug
BNC-7314-75	Inline Splice, Jack
BNC-7862	Terminator Plug, 1 %, Die Casted
BNC-7865	Terminator Jack, 1% & 1/2W, Die Casted



BODY ONLY

- 50pcs. per Bag

BNC-BDP-RG59 For RG59/U, 62/U
BNC-BDP-RG58 For RG58/U Cable
BNC-BDP-RG5975 For RG59/U, 75Ω
BNC-BDP-RG59-DC Die Cast
BNC-PNS-3022 For RG58/U, w/o Shell



FERRULES

- 50pcs. per Bag

FER-3.2-174U Ferrule, (I.D. 3.2mm), for RG-174/U
FER-3.7-735A Ferrule, (I.D. 3.7mm), for 735A
FER-4.45-8218 Ferrule, (I.D. 4.45mm), for Belden 8218
FER-5.3-58U Ferrule, (I.D. 5.3mm), for RG-58/U
FER-5.6-58U Ferrule, (I.D. 5.6mm), for RG-58/U
FER-6.6-59U Ferrule, (I.D. 6.6mm), for RG-59/U
FER-6.9-8X Ferrule, (I.D. 6.9mm), for 8X (Mini 8/U)
FER-7.6-6U Ferrule, (I.D. 7.6mm), for RG-6/U
FER-8.0-6U Ferrule, (I.D. 8.0mm), for RG-6/U
FER-8.5-8281 Ferrule, (I.D. 8.5mm), for Belden 8281
FER-10.6-8U Ferrule, (I.D. 10.6mm), for RG-8/U
FER-10.7-L400 Ferrule, (I.D. 10.7mm), ID for L400
FER-10.9-214U Ferrule, (I.D. 10.9mm), for RG-214U
FER-T3044-179-U Step Ferrule, for RG-179/U
FER-T4756-58U Step Ferrule, for RG-58/U
FER-T5466-59U Step Ferrule, for RG-59
FER-T6584-6U Step Ferrule, (I.D. 6.5mm), for RG-6 



PVC



Plenum (Step Ferrule)

PINS

- 50pcs. per Bag

Captive Pin with 3μ" Gold Plated

Male Pin

BNC-P/M-0.5-179 Bore 0.50mm, For RG-179
BNC-P/M-0.6NC **Non-Captive**, Bore 0.60mm
BNC-P/M-0.76 Bore 0.76mm, (22 AWG)
BNC-P/M-0.90 Bore 0.90mm, (20 AWG)
BNC-P/M-1.10 Bore 1.10mm, (18 AWG)
BNC-P/M-1.4-11 Bore 1.40mm, For RG-11
BNC-P/M-1.6 Bore 1.60mm, For RG-11 
BNC-P/M-1.7-11 Bore 1.70mm, For RG-11
BNC-P/M-2.9-L400 Bore 2.90mm, For LMR400



Male Pin

Female Pin

BNC-P/F-0.76 Bore 0.76mm, (22 AWG)
BNC-P/F-0.90 Bore 0.90mm, (20 AWG)
BNC-P/F-1.10 Bore 1.10mm, (18 AWG)

















Female Pin

All Captive Pin with 30μ" Gold Plated

BNC-PIN/M-0.76-30U" Pin Hole (Bore 0.76mm)
BNC-PIN/M-0.90-30U" Pin Hole (Bore 0.90mm)
BNC-PIN/M-1.10-30U" Pin Hole (Bore 1.10mm)
BNC-PIN/M-1.2-30U" Pin Hole (Bore 1.2mm) 

BNC ADAPTORS

<p>Bulkhead Feed Thru Isolated (UG-492D/U)</p>  <p style="text-align: right;">BNC-3191</p>	<p>Bulkhead Feed Thru (UG-492D/U)</p>  <p>BNC-3192 BNC-3192-75(75Ω) BNC-7192</p>	<p>Bulkhead Feed Thru Isolated (UG-492D/U)</p>  <p>BNC-3193 BNC-3193-75(75Ω)</p>	<p>BNC M-F Right Angle (UG-306A/U, M-F)</p>  <p>BNC-3306 BNC-3306-75(75Ω)</p>
<p>Jack-Jack (UG-914/U, F-F)</p>  <p>BNC-3314 BNC-7314 BNC-3314-75(75Ω) BNC-3314-BULK (100/Pack)</p>	<p>Jack-Plug-Jack (UG-274B/U, F-M-F)</p>  <p>BNC-3374 BNC-3874 BNC-7374 BNC-3374-75(75Ω) BNC-3374-SJ - Soldered Joint BNC-3374-BULK (100/Pack)</p>	<p>Jack-Jack-Jack "T" Adaptor</p>  <p>BNC-3375 BNC-7375 BNC-3375-75(75Ω)</p>	<p>Plug-Plug (UG-491/U, M-M)</p>  <p style="text-align: right;">BNC-3391</p>
<p>Jack-Plug-Jack "Y" Adaptor, 180°</p>  <p style="text-align: right;">BNC-7366</p>	<p>Jack-Plug-Jack "Y" Adaptor, 90°</p>  <p style="text-align: right;">BNC-7367</p>	<p>Plug-Jack-Jack "F" Adaptor</p>  <p style="text-align: right;">BNC-7368</p>	<p>Plug-Plug-Plug "T" Adaptor</p>  <p style="text-align: right;">BNC-7376</p>
<p>P.C.B Mount, 180° Low Profile</p>  <p style="text-align: right;">BNC-3878</p>	<p>P.C.B Mount, 90° Low & High Profile</p>  <p>BNC-3879L Right Angle Low Profile H:15.6mm (Reference)</p> <p>BNC-3879H Right Angle High Profile H:13.1mm (Reference)</p>		

TERMINATORS

• All Terminators have a Power Rating of 0.5 Watts.

Plugs

BNC-3061	50 Ω
BNC-3061-1	50 Ω, 1%
BNC-3061-2	50 Ω, 1%, W/Chain, Green Cap
BNC-7861	50 Ω, 1%, Die Casted
BNC-3062	75 Ω
BNC-3062-1	75 Ω, 1%
BNC-3062-2	75 Ω, 1%, W/Chain, Purple Cap
BNC-7862	75 Ω, 1%, Die Casted
BNC-3063	93 Ω
BNC-3063-1	93 Ω, 1%
BNC-3063-2	93 Ω, 1%, W/Chain, White Cap
BNC-7863	93 Ω, 1%, Die Casted
BNC-3061-BULK	100/PACK

Jacks

BNC-7864	50 Ω
BNC-7865	75 Ω
BNC-7866	93 Ω

• All Jacks are 1%, Die Casted Body



COAX PLUG COLOR BAND

• For BNC and TNC Only.

CCB-(CC)



CC: BK, BL, GN, OR, RD, WH, YW.



DUST CAPS

For Jacks

BNC-DSTCP-P



For Plugs

BNC-DSTCP-S



BUSHING & WASHER

BNC-RG62-BUSH Bushing for RG-62 Type Cable

BNC-WSHR Washer, ID: 0.425"

BNC-SLDRING RF/BNC Solder Ring Terminator

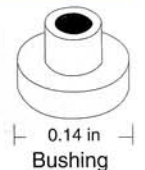

BNC FEMALE (JACK) TO OTHERS

<p>BNC (F) - UHF Female</p>  <p>RFA-8311</p>	<p>BNC (F) - UHF Male</p>  <p>RFA-8312</p>	<p>BNC (F) - R.P. BNC Plug</p>  <p>RFA-8332</p>	<p>BNC (F) - N Female</p>  <p>RFA-8361</p>	<p>BNC (F) - N Male</p>  <p>RFA-8362</p>
<p>BNC (F) - F Male</p>  <p>RFA-8372</p>	<p>BNC (F) - SMA Female</p>  <p>RFA-8381</p>	<p>BNC (F) - SMA Female</p>  <p>RFA-8381PM</p>	<p>BNC (F) - Mini UHF Male</p>  <p>RFA-8322</p>	<p>BNC (F) - TNC Female</p>  <p>RFA-8341</p>
<p>BNC (F) - TNC Male</p>  <p>RFA-8342</p>	<p>BNC (F) - SMA Male</p>  <p>RFA-8382</p>	<p>BNC (F) - RCA Female</p>  <p>RFA-8391</p>	<p>BNC (F) - BNC Female</p>  <p>BNC-3314 BNC-7314 BNC-3314-75(75Ω)</p>	<p>BNC (F) - F Female</p>  <p>RFA-8371</p>

BNC (F) - RCA Male



RFA-8392
RFA-8392X
RFA-8392-BULK
RFA-8392-75(75Ω)
RFA-8392Z - Die Cast



See RFA Series Table on pgs 73-74

BNC MALE (PLUG) TO OTHERS

<p>BNC (M) - UHF Female</p>  <p>RFA-8313</p>	<p>BNC (M) - Mini UHF Female</p>  <p>RFA-8323</p>	<p>BNC (M) - R.P. BNC Jack</p>  <p>RFA-8333</p>
<p>BNC (M) - TNC Female</p>  <p>RFA-8343</p>	<p>BNC (M) - N Female</p>  <p>RFA-8363</p>	<p>BNC (M) - F Female</p>  <p>RFA-8373</p>
<p>BNC (M) - SMA Female</p>  <p>RFA-8383</p>	<p>BNC (M) - SMA Male</p>  <p>RFA-8384</p>	<p>BNC (M) - RCA Male</p>  <p>RFA-8394 L: 6.5mm RFA-8394Z - Die Cast</p>
<p>BNC (M) - RCA Male</p>  <p>RFA-8394L L: 9.0mm</p>	<p>RFA-8393 RFA-8393X RFA-8393-BULK RFA-8393-75(75Ω) RFA-8393Z - Die Cast</p>	