

SURGE PROTECTED POWER STRIPS

Power strip with **Circuit Breaker**. Protect equipment from electrical spikes and power surges. **UL** and **CSA** Listed.

- Electrical Rating: 125 V, 15 A, 1875Watts
- Clamping Voltage: 400 V (500 V pm 7Ps)
- Current Peak: 4000 A
- Response Time: 7 ~ 12 nanoseconds
- Energy Absorption: 50/150 Joules
- Power Cord: 14 AWG, UL SJT



PS-SPPP-6PTL 6 Outlet Ports, Teal

PS-PPAD-5P 5 Ports, 5 Switches, Individual Control

Power strip with **Circuit Breaker**. **Enamel Metal** cover with **Six Grounded Outlets (5 on PS-PPAD-5P)**. **Reset Button** and **6ft Power Cord**. **3 MOV** Full Surge Protection, Surge Protected **Modem Jacks (PS-PERM-6P/M)**, **EMI/RFI** Noise Filter Protect equipment from electrical spikes and power surges. **UL** and **CSA** Listed.

- Electrical Rating: 125 V, 15 A, 1875Watts
- Clamping Voltage: 400 V (500 V on 5Ps)
- Current Peak: 4000 A (4500A on 5Ps)
- Response Time: 7 ~ 12 nanoseconds
- Energy Absorption: 50/150 Joules
- Power Cord: 14 AWG, UL SJT



PS-PERM-6P/M Enamel Metal Casing, Modem Jacks

POWER OUTLETS

- Heavy Duty Power Cord
- Safety Circuit Breaker
- Master Switch

PS-SPPP7PD EMI/RFI Noise Filter, 6 Outlets Plus 1 Extra for Transformer



- Cat. 5 High Speed Dataline Port
- 6 Color-Coded Outlets
- 2 Transformer Outlets
- 2-Line Dataline Port

PS-SPPP-8P-N



- 6 Outlets in 2 Rows
- Phone Line Surge Protection
- EMI/RFI Noise Filter
- 3 MOV

PS-SPPP-6PDM



- 5 Outlets with Sideway Alignment
- Phone Line Surge Protection
- EMI/RFI Noise Filter
- 3 MOV

PS-SPPP-5PSWM

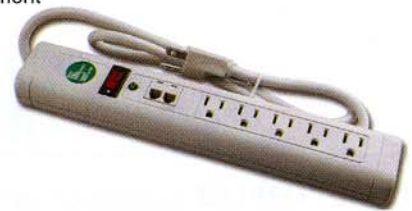

LOADED PANELS

Part #	High	Ports	Components Part No.	Remark/Notes
WPK-25HS/T-24	2U	24	DH-25HS/T	
WPK-B3191-16A	1U	16	BNC-3191	
WPK-B3191-16B	2U	16	BNC-3191	
WPK-B3191-24	2U	24	BNC-3191	
WPK-B3191-2X8	2U	16	BNC-3191	Dual Row (8 Ports each)
WPK-B3191-32	2U	32	BNC-3191	
WPK-B3192-16A	1U	16	BNC-3192	
WPK-B3192-16B	2U	16	BNC-3192	
WPK-B3192-24	2U	24	BNC-3192	
WPK-B3192-32	2U	32	BNC-3192	
WPK-B3193-16A	1U	16	BNC-3193	
WPK-B3193-24	2U	24	BNC-3193	
WPK-B3193-32	2U	32	BNC-3193	
WPK-J10218-32	2U	32	DC-1021-8C-BK	
WPK-LGC25FF16-B	2U	16	AD-LGC-25FF	
WPK-WANG-32	2U	32	BNC-3192/TNC-3461	

RACKS

WRP-RACK Grey Hammer tone finish, Mounting Rails Drilled & Tapped

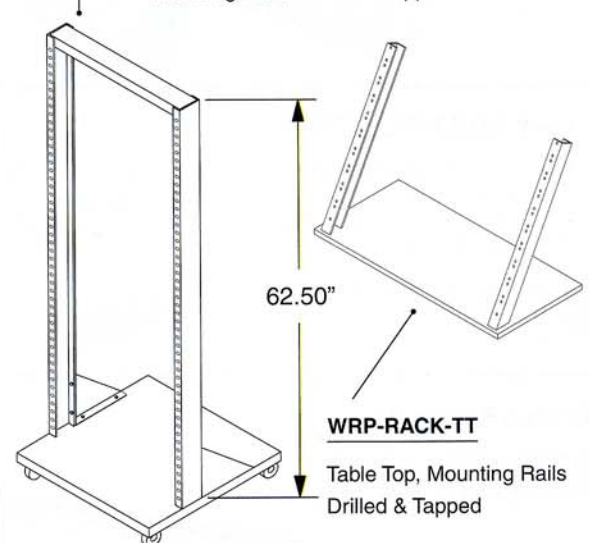

STAINLESS STEEL WALL PLATES



SINGLE GANG

WP-09-1H	For DB9	WP-09-2H
WP-15-1H	For DB15	WP-15-2H
WP-25-1H	For DB25	WP-25-2H

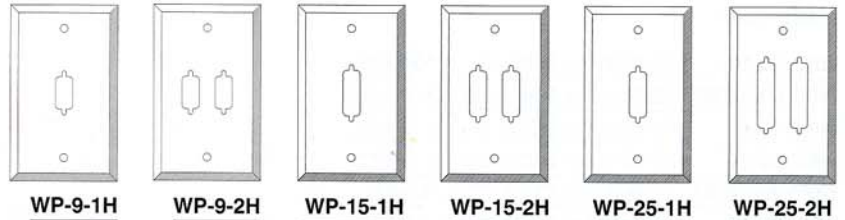

WP-25/C	For DB25, Coax 1/2" dia.
WP-25/M	For DB25, Keystone Jack
WP-25/T11	
WP-25/TW	For DB25, Twinax, 1 Hole
WP-36-1H	For Centronics 36, 1 Hole

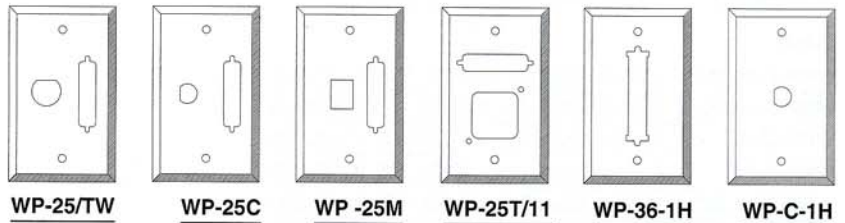

WP-C-(XX)H	For Coax FeedThru, 1/2" dia.
WP-C-(XX)H3/8	For Coax, 3/8" dia.
WP-C/M	For Keystone Jack and Coax, 1/2" dia.
WP-IBM-1	For Data Connector
WP-IBM/C	For Data & Coax

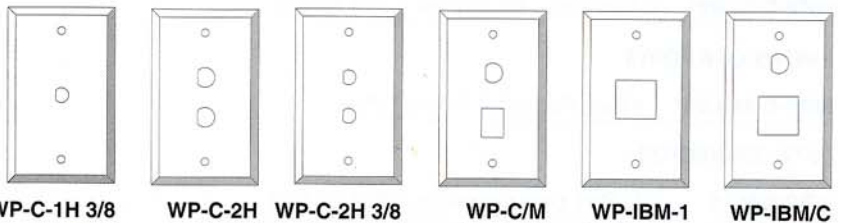

(XX) Indicates No. of Holes: 1, 2

WP-IBM/M	For Data Connector, Keystone Jack 1 Hole
WP-M-(XX)H	For Keystone Jack
(XX) Indicates No. of Holes: 1, 2, 3, 4, 6	
WP-TW-(XX)H	For Twinax
(XX) Indicates No. of Holes: 1, 2	
WPS	Blank Plate, Single Gang

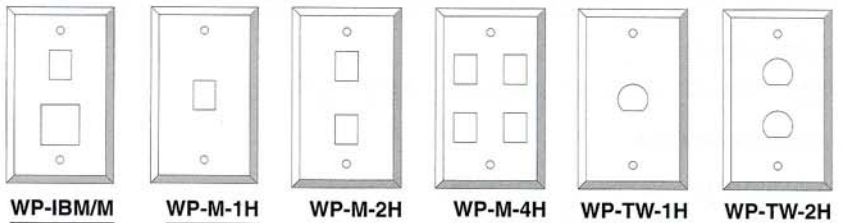

DOUBLE GANG

WP-15-1HD	For DB15, 1 Hole
WP-25-2HD	For DB25, 2 Holes
WP-25-4HD	For DB25, 4 Holes
WP-37-1HD	For DB3, Dual Gang, 1 Hole

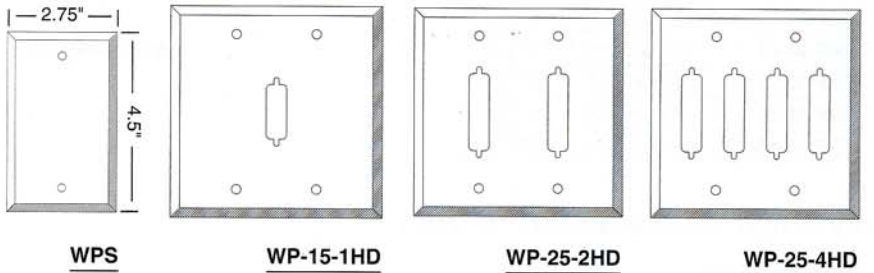

WP-25MD	For DB25 1 Hole, 2 Keystone, 2 Hole
WP-C-2HD	For Coax, 1/2" DIA, 2 Holes
WP-M-4D	For Keystone Jack, 4 Holes
WPD	Blank Plate

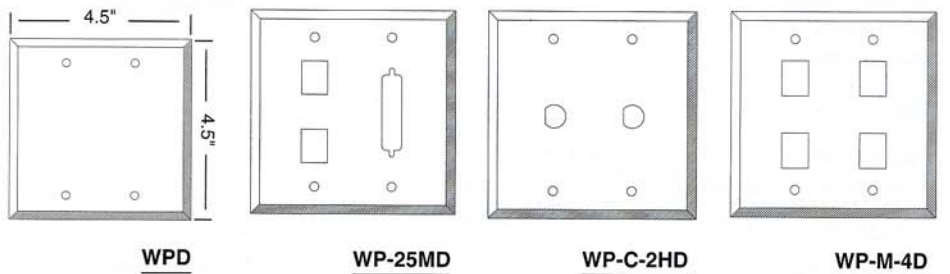

UNIVERSAL FITTING

WP-MA-2	Dual Port
WP-MA-4D	Quad Port, Double Gang





19" RACK MOUNT PANELS

FOR D-SUB

WRP-09-16	16 Port, For DB9, 3.5" X 19"(2U)
WRP-09-32/3U	32 Port, For DB9, 5.25" X 19"(3U)
WRP-15-16	16 Port, For DB15, 3.5" X 19"(2U)
WRP-25-16	16 Port, For DB25, 3.5" X 19"(2U)
WRP-25-32/4U	32 Port, For DB25, 7" X 19"(4U)
WRP-37-16	16 Port, For DB37, 3.5" X 19"(2U)
WRP-D50-16	16 Port, For DB50, 3.5" X 19"(2U)

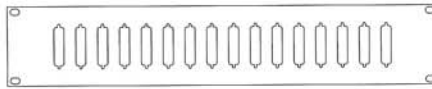

WRP-25-16

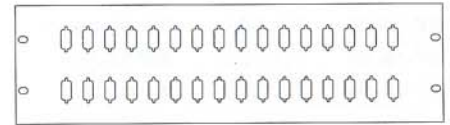

WRP-09-32/3U

COAX

WRP-C-16 3/8"	16 Port, Coax For 3/8" dia. 3.5" X 19"(2U)
WRP-C-16/1U	16 Port, Coax, For 1/2" dia. 1.75" X 19"(1U)
WRP-C-16	16 Port, Coax, For 1/2" dia. 3.5" X 19"(2U)
WRP-C-24	24 Port, Coax, For 1/2" dia. 3.5" X 19"(2U)
WRP-C-24 3/8"	24 Port, Coax For 3/8" dia. 3.5" X 19"(2U)
WRP-C-32	32 Port, Coax, For 1/2" dia. 3.5" X 19"(2U)
WRP-C-32 3/8"	32 Port, Coax, For 3/8" dia. 3.5" X 19"(2U)



WRP-C-16/1U



WRP-C-24 3/8"

2 ROWS OF 8 PORTS

WRP-C-2X8 3/8"	6 Port, For 3/8", 3.5" X 19" (2U)
-----------------------	-----------------------------------

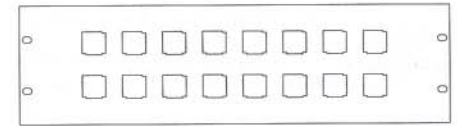

WRP-IBM-16/3U

DATA CONNECTOR

WRP-IBM-12	12 Port, Data Connector, 3.5" X 19"(2U)
WRP-IBM-12/1U	12 Port, Data Connector, 1.75" X 19"(1U)
WRP-IBM-16/3U	12 Port, Data Connector, 5.25" x 19"(3U)

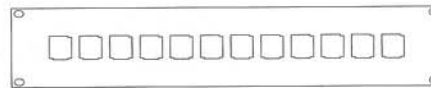

WRP-IBM-12

DATA & VOICE

WRP-IBM/M-12	12 Port Set, Data & Voice, 3.5" X 19"(2U)
---------------------	---

VOICE CONNECTOR

WRP-M-12/1U	12 Port, 1.75" X 19"(1U)
WRP-M-12	12 Port, 3.5" X 19"(2U)
WRP-M-16/1U	16 Port, 1.75" X 19"(1U)
WRP-M-16	16 Port, 3.5" X 19"(2U)
WRP-M-24	24 Port, 3.5" X 19"(2U)
WRP-M-32	32 Port, 3.5" X 19"(2U)
WRP-M-48	48 Port, 3.5" X 19"(2U)
WRP-M-48/3U	48 Port, 5.25" X 19"(3U)

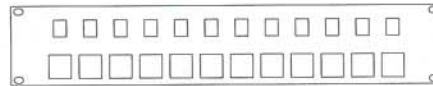

WRP-IBM/M-12



WRP-M-48/3U

UV FITTING (See Page 30 for Modular Frame)

WRP-MA-12/1U
WRP-MA-16/1U
WRP-MA-24
WRP-MA-32



WRP-MA-12/1U

FORTWINAX

WRP-TW-16	16 Port, For Twinax, 3.5" X 19"(2U)
WRP-TW-24	24 Port, For Twinax, 3.5" X 19"(2U)
WRP-TW-32	32 Port, For Twinax, 3.5" X 19"(2U)



WRP-TW-16

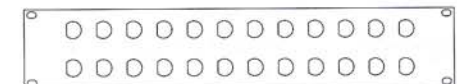

WRP-TW-24

BLANK PLATE

WRP-19/1.75	Blank plate, 1.75 X 19"
WRP-19/3.5	Blank plate, 3.5" X 19"



WRP-19/3.5

"X" SERIES RACK PLATE **RoHS**

WRP-X-24	19", 24 Port, Unloaded.
-----------------	-------------------------



BNC FEED THRU PLATE

- Screw Retaining Barrel Nut on Both Side
- Fitted w/ BNC Feed Thru (See Pg. 59)

<u>WPK-B(XXX)-1</u>	BNC Fitted WP-C-1H
<u>WPK-B(XXX)-2</u>	BNC Fitted WP-C-2H
<u>WPK-B(XXX)-2D</u>	BNC Fitted WP-C-2HD

(XXX) Indicates BNC Part Number: 3191, 3192, 3193

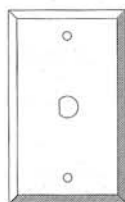

WP-C-1H

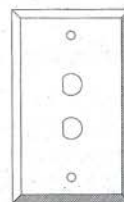

WP-C-2H

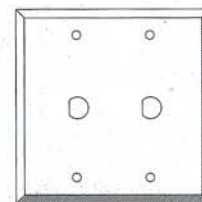

WP-C-2HD

TWINAX FEED THRU PLATE

- Screw Retaining Barrel Nut on Both Side
- Fitted w/ Twinax Feed Thru (See Pg. 58)

WPK-TW3502-1 WP-TW-1H Fitted with TWX-3205

WPK-TW3502-2 WP-TW-2H Fitted with TWX-3205

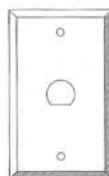

WP-TW-1H



WP-TW-2H

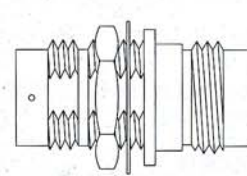

TWX-3502

D-SUB CONNECTORS

<u>WPK-09HS/T(X)</u>	9 HS/T
<u>WPK-09P-2</u>	DS-9P 2 Holes
<u>WPK-25HS-2</u>	DH-25HS
<u>WPK-25HS/T-1</u>	DH-25HS/T
<u>WPK-25S-1</u>	Single Gang Wall Plate, DS-25S, one port



(X) Indicates No of Holes: 1, 2

KEYSTONE FEED THRU PLATE

WPK-M6C-25P/T Loaded Wall Plate with Keystone and DB25PP

WPH-103B-F-IV "F" Loaded Wall Plate (Ivory)

WPH-103B-F-WH "F" Loaded Wall Plate (White)

BNC SOLDER JACK LOADED PANEL

<u>WPK-B(XXX)-16</u>	BNC Fitted WRP-C-16-3/8"
<u>WPK-B(XXX)-24</u>	BNC Fitted WRP-C-24-3/8"
<u>WPK-B(XXX)-32</u>	BNC Fitted WRP-C-32-3/8"

(XXX) Indicates BNC Part Number:

3194, 3194T, 3195, 3196, 3199, 7194, 7194T

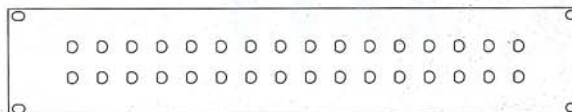

WRP-C-32 3/8"

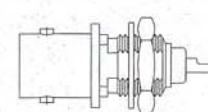

BNC-3195

BNC FEED THRU LOADED PANEL

<u>WPK-B(XXX)-16(L)</u>	BNC Fitted WRP-C-16
<u>WPK-B(XXX)-24</u>	BNC Fitted WRP-C-24
<u>WPK-B(XXX)-32</u>	BNC Fitted WRP-C-32

(L) Indicates Panel Height: A for 1.75"

B for 3.5"

(XXX) Indicates BNC Part Number: 3191, 3192, 3193

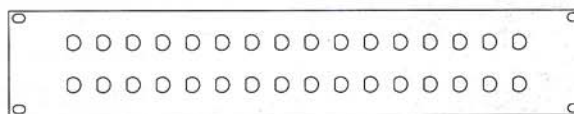

WRP-C-32

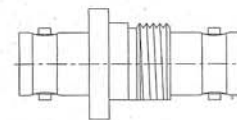

BNC-3191

TWINAX CONNECTOR LOADED PANEL

WPK-TW(XXX)-16 TWX Fitted WRP-TW-16

(XXX) Indicates TWX Part Number: 3502, 3504

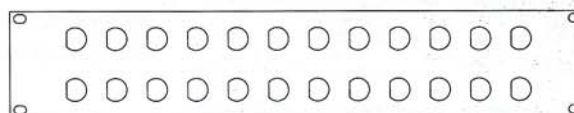

WRP-TW-24

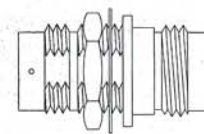

TWX-3502