

ROPE PULL SWITCH ACCESSORIES

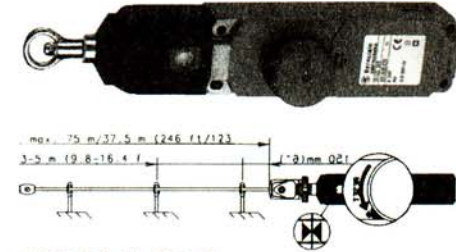

#SRU 2ZNA QF300
 Max length 240 ft.
 Rope supports every 9' → 16' feet.

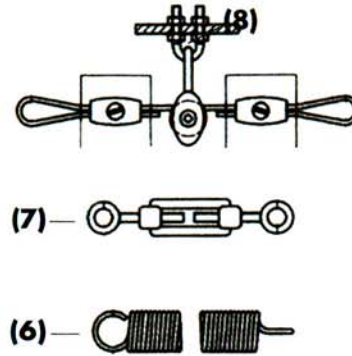
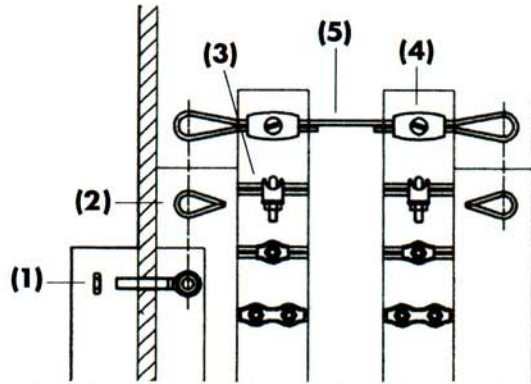

(1) Nut Eye Bolt

List

M 6 x 50 Bolt
(6mm x 50mm)

\$8

M 10 x 50 Bolt
(10mm x 50mm)



(2) Thimble

List

R-Thimble

\$2.50



(3) Rope Clamp

List

R-Clamp

\$3



(4) Screw Clamp

List

R-Clamp

\$3



(6) Spring

For use on bi-directional switches

R-Spring
(5lbs.)

List

\$12

For use on Sil, SiRK rope pull switches



(7) Turnbuckle

List

R-Turnbuckle

\$15



(8) Swivel Pulley Block w/clamp

List

R-Pulley

\$20













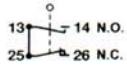

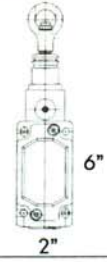
(5) Red Cable Metal Rope

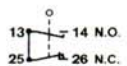
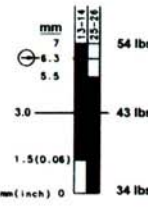
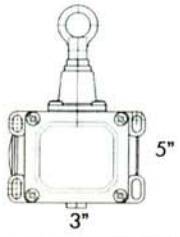
List

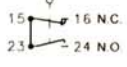
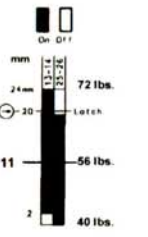
#Cable ___ ft.
 ___ enter ft.
 ex: Cable 100ft.

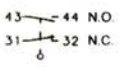
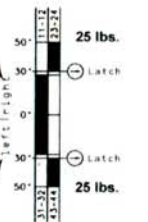
\$0.80

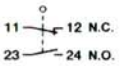
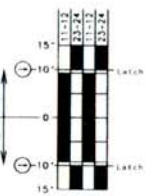
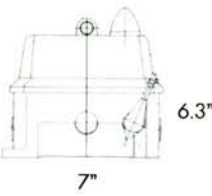
per ft.

Contacts	Max. Rope Cable Length	Amps/Volts AC UL + CSA	Dimensions	Operations Per Minute	Pre-Tension Force	Part# NEMA 4, 12	List	Housings
 	20 ft.	10A / 300V		17	14.7 lbs.	SiEM2-UVIZRast reset button	\$210	 Aluminum
 	32 ft.	10A / 300V		50	43 lbs.	SiD-UVIZ no reset (spring return)	\$158	 Aluminum
 	162 ft.	10A / 300V		20	56 lbs.	SiN-UVIZPRast reset button	\$570	 Aluminum
 	325 ft.	10A / 250V IEC - NO UL CSA		10	0 lbs.	SiU1Z/U1ZAKR-R pull ring reset	\$560	 Iron
Two Rope Springs required (one on each side) for pre-tension								
 	325 ft.	10A / 250V		30	0 lbs.	SiRK-U2ZRMLD pull lever reset	\$560	 Plastic Housing with Pilot Light
Two Rope Springs required (one on each side) for pre-tension								