

Safety Hinge Switch

SHS

IP 67 Metal housing



design award
winner
2002



Hinged machinery guards and covers as well as safety fence doors may be found in every type of industry.

The safety hinge switch SHS is the logical integration of the safety switch and load-bearing hinge for industrial applications.

Designed to facilitate mounting onto extruded aluminium profiles, steel or plastic doors, the slim profile of the SHS even when fully closed, allows the hinge to be readily mounted where space is constrained.

Traditional safety switches with separate actuator keys are often subject to mechanical wear, particularly when mounted on the closing edge of guards where accumulated tolerances can cause misalignment. The SHS removes this problem with the safety contact mounted internally, inaccessible to the user and therefore providing excellent tamper protection. One or more switches may be used dependent on the category of safety protection required. Matching hinges without safety contacts are also available, allowing the style to be standardised for general use. In operation, consideration must simply be given to the required contact operation angle, which is determined by guard size and the maximum allowable guard opening distance before actuation.



Safe:

- 2 SHS hinge switches each with a force disconnect safety contact allow safety category 4 systems to be configured subject to the required risk analysis and safety contact monitoring.

Flexible:

- The hinge operating angle is 0–180°.
- The switch point may similarly be selected through 180°.
- AC/DC to 250 V or 60 V DC versions available.

Fast:

- Connectors as well as fixed cable versions with axial and radial (rear) mounting are available.

Reliable:

- A cast Zinc alloy body allows the SHS a high degree of mounting freedom.
- In its hinge capacity the SHS can bear up to 750 N axially and 1000 N radially, after the switching point has been set.
- Ingress protection to IP 67.

SHS types overview

| Art.-No. | Description | Contact function | Type DC | Type AC/DC | Quick Disconnect | | Fixed Cable | | BG-Type Approval |
|------------|-----------------|-------------------------------------|---------|------------|------------------|-------------|-------------|-------------|------------------|
| | | | | | axial (SA) | radial (SR) | axial (KA) | radial (KR) | |
| 6019261009 | SHS-A1Z-SA | A1Z | – | X | Metal | – | – | – | – |
| 6019261010 | SHS-A1Z-SR | A1Z | X | – | – | Plastic | – | – | – |
| 6019261011 | SHS-A1Z-KA 5-BG | A1Z | – | X | – | – | X | – | BG |
| 6019261014 | SHS-A1Z-KR 5-BG | A1Z | – | X | – | – | – | X | BG |
| 6019261015 | SHS-A1Z-SA | A1Z | X | – | Metal | – | – | – | – |
| 6019261016 | SHS-A1Z-SR | A1Z | – | X | – | Metal | – | – | – |
| 6019261017 | SHS-A1Z-SA-BG | A1Z | – | X | Metal | – | – | – | BG |
| 6019261018 | SHS-A1Z-SR-BG | A1Z | – | X | – | Metal | – | – | BG |
| 6019291013 | SHS-OZ | Hinge without safety contact | – | – | – | – | – | – | – |

True Category 4 (EN 954-1/2)

- true electrical redundancy
- true mechanical redundant safety
- avoids mechanical common mode failure

Installation example:

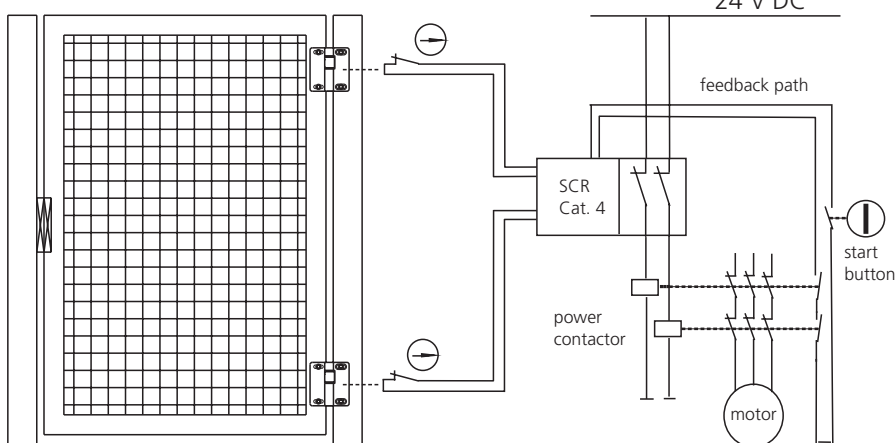

Plug M 12 x 1 with moulded cable

Terminal code,
AC/DC configuration

- 1 = green-yellow
- 2 = black
- 3 = blue

AC/DC configuration

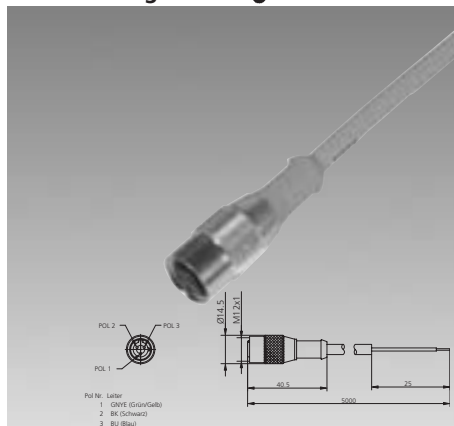

Straight line

Right-angled

on request

on request

AN-KAB.SHS 5M AC Gerade
325.1103.234

AN-KAB.SHS 5M Winkel
325.1103.236

-

-

| | |
|--------------------------------------|---------------------------------|
| Material of cable sleeve: | PVC (UL)/PVC (UL) |
| Material body/Contact carrier: | PUR (UL)/PUR (UL) |
| Rated voltage max.: | 300 V AC |
| Current carrying capacity max.: | 3 A |
| Temperature range min./max.: | -25 °C/+70 °C -13 °F/+158 °F |
| Cable structure mm ² : | 3 x 0,5 |
| Protection class after installation: | IP 67 |

Terminal code,
DC configuration

- 1 = brown
- 2 = -
- 3 = blue
- 4 = black

DC configuration

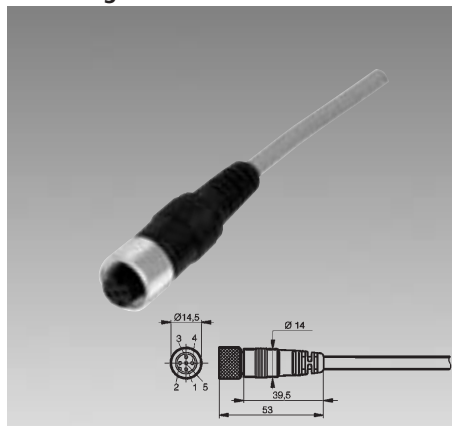

Straight line

Right-angled

AN-KAB.SHS 2M DC

AN-KAB.SHS 2M DC

325.1003.221

325.1003.224

AN-KAB.SHS 5M DC

AN-KAB.SHS 5M DC

325.1003.222

325.1003.225

AN-KAB.SHS 10M DC

AN-KAB.SHS 10M DC

325.1003.223

325.1003.226

| | |
|--------------------------------------|---------------------------------|
| Material of cable sleeve: | PVC/PVC |
| Material body/Contact carrier: | PUR/PUR |
| Rated voltage max.: | 60 V AC/75 V DC |
| Current carrying capacity max.: | 1.5 A |
| Temperature range min./max.: | -25 °C/+70 °C -13 °F/+158 °F |
| Cable structure mm ² : | 3 x 0.34 |
| Protection class after installation: | IP 67 |

Terminal code,
AC/DC configuration

- 1 = brown
- 2 = black
- 3 = blue
- 4 = green-yellow

AC/DC configuration

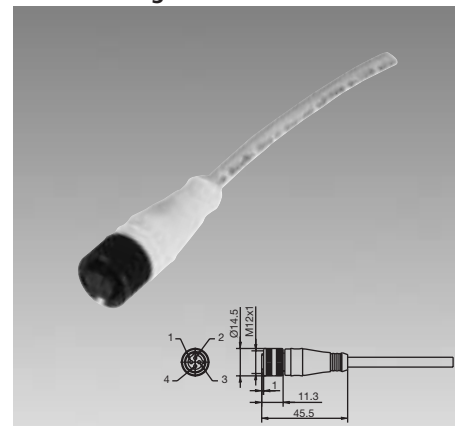

Straight line

Right-angled

-

-

AN-KAB.SHS 5M AC
325.1004.219

AN-KAB.SHS 5M AC
325.1004.220

-

-

| | |
|--------------------------------------|--------------------------------|
| Material of cable sleeve: | PVC/PVC |
| Material body/Contact carrier: | PUR/Nylon 6.6 |
| Rated voltage max.: | 300 V AC |
| Current carrying capacity max.: | 4.0 A |
| Temperature range min./max.: | -5 °C/+70 °C +23 °F/+158 °F |
| Cable structure mm ² : | 4 x 0.34 |
| Protection class after installation: | IP 68 |

Safety Hinge Switch

SHS



Designation
Part number
 Contact diagram
 ⊕ Forced disconnect to IEC 947-5-1 annex k
 Za: non-galv. separated contact
 Zb: galv. separated contact
 Slow make and break/Snap action
 Sealed internally (iw)/externally (w)

SHS-A1Z-SA-BG
601.9261.017

 C
 ●/-
 iw

SHS-A1Z-SR-BG
601.9261.018

 C
 ●/-
 iw

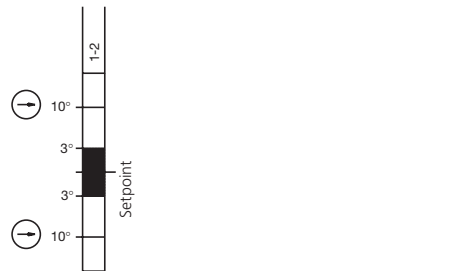
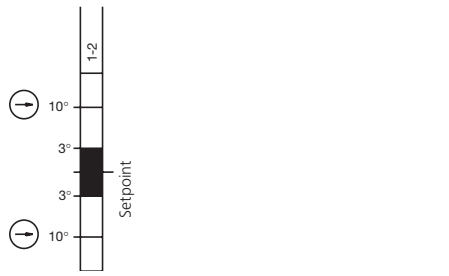
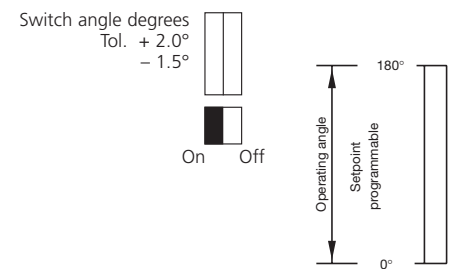

Switching hysteresis: - 1.0°
 Voltage max.
 Thermal current max.
 Utilization category per IEC 947-5-1 AC 15/DC 13
 Switching frequency max.
 Mechanical life – switching operations
 Operating temperature min./max.
 Approvals
 Weight
 Delivery: ex-stock/built to order

250 VAC
 3 A
 60 V DC/0.5 A
 230 V AC/1.5 A
 1200/h
 1 x 10⁶
 -25 °C/+70 °C
 -13 °F/+158 °F
 BG, UL, CSA
 0.4 kg
 ●/-

250 VAC
 3 A
 60 V DC/0.5 A
 230 V AC/1.5 A
 1200/h
 1 x 10⁶
 -25 °C/+70 °C
 -13 °F/+158 °F
 BG, UL, CSA
 0.4 kg
 ●/-

All dimensions in mm

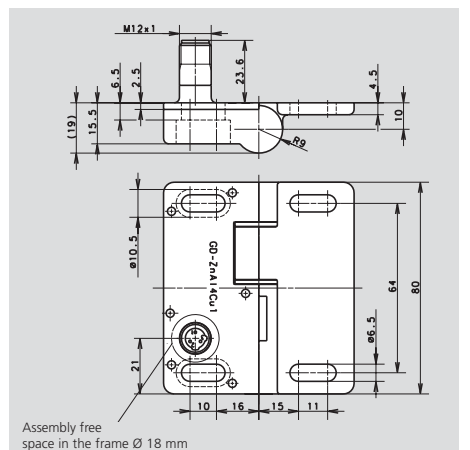
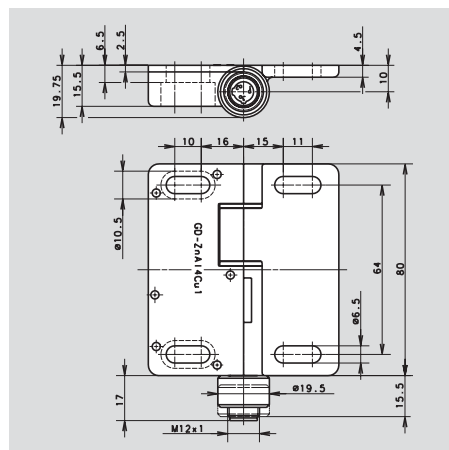
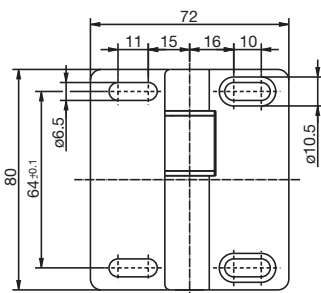



SHS-A1Z-KA 5
601.9261.011

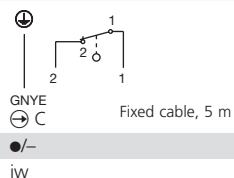

SHS-A1Z-KR 5
601.9261.014

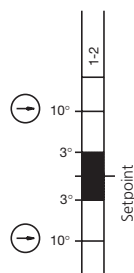
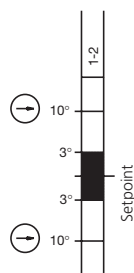
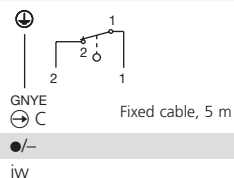

250 VAC
3 A
60 V DC/0.5 A
230 V AC/1.5 A
1200/h
1 x 10⁶
-25 °C/+70 °C
-13 °F/+158 °F

250 VAC
3 A
60 V DC/0.5 A
230 V AC/1.5 A
1200/h
1 x 10⁶
-25 °C/+70 °C
-13 °F/+158 °F

BG, UL, CSA
0.4 kg
●/-

BG, UL, CSA
0.4 kg
●/-

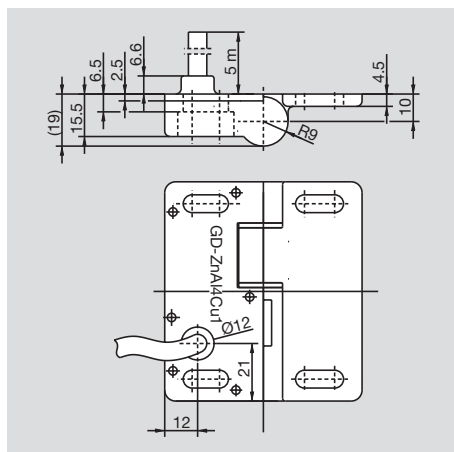
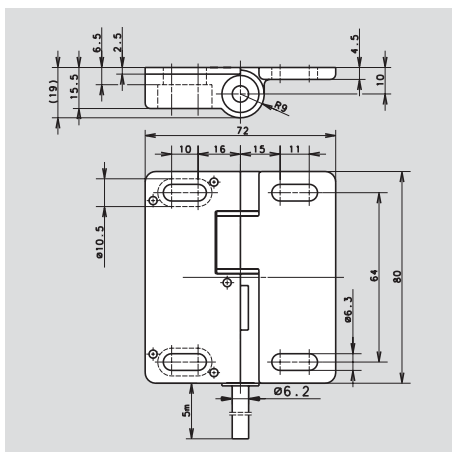



SHS-A1Z-SA
601.9261.015

SHS-A1Z-SR
601.9261.010

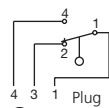
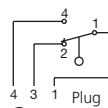

⊕ C
●/-
iw

⊕ C
●/-
iw

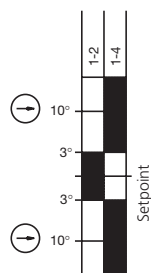
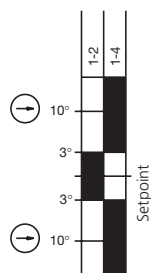

250 VAC
3 A
60 V DC/0.5 A
-
1200/h
1 x 10⁶
-25 °C/+70 °C
-13 °F/+158 °F

250 VAC
3 A
60 V DC/0.5 A
-
1200/h
1 x 10⁶
-25 °C/+70 °C
-13 °F/+158 °F

UL, CSA
0.4 kg
●/-

UL, CSA
0.4 kg
●/-

