



Plumbing Tools

Tubing Cutters
Mini Tubing Cutters
Cutting Tools
Flaring Tools
Bending Tools
Reamers
Deburring Tools
Cleaning Brushes
Wrenches
Pliers
Faucet Tools

PLUMBING TOOLS

Tubing Cutters



THE GOLD STANDARD PROFESSIONAL SERIES

All General Tools Professional Tubing Cutters, come standard with these customer proven features:

- **One** Bearing tool steel cutting wheel, machined to the perfect geometry and through hardened, that fits all General cutters.
- **Wider** hardened and polished Flared Grooved Rollers for reliable, stable and true close end

cutting on flared tubing. Our rollers are mounted on hardened solid pins for longer, friction free operation.

- **Powder Coated** baked on painted finish for durability, corrosion resistance and great look.
- **All fasteners** are drilled and tapped for precision fit and strength, not riveted or pinned.

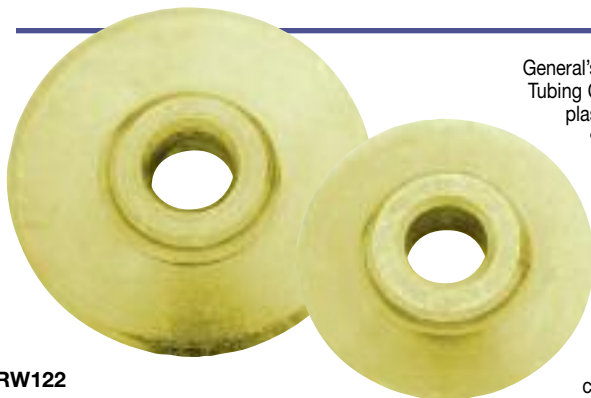

RW122

General's Gold Standard Tubing Cutter Wheels are the new Quality Standard Replacement Cutters for all General Tubing Cutters! Now with our new slim-line design only 2 cutter wheels are needed to cut copper, plastic, iron pipe and stainless steel.

- Our Gold Standard cutter wheels include these features:

Shape: New, sleek, slim-line geometry provides for smooth, clean effortless cutting on all Pipes and Tube Materials.

Strength: Bearing Tool Steel for superior strength to withstand the greater cutting pressure.

Durability: Through hardened and tempered to maintain its sharp edge and reduce chipping or breaking.

Speed: The combination of shape, strength and durability enable General's New GOLD Standard to repeatedly provide quicker cutting without deforming the pipe OD and cuts with minimum ID burring.

RW121/2 - For thin wall cutting-Fits all General tubing cutters, Pro or Classic series; mini, standard or high performance sizes. (Packed 2 per card).

RW122 - Larger capacity: For iron or PVC pipe-Fits Nos. 1240, 120, 125, 1259, 126 and 127 cutters. (Replaces RW122P)

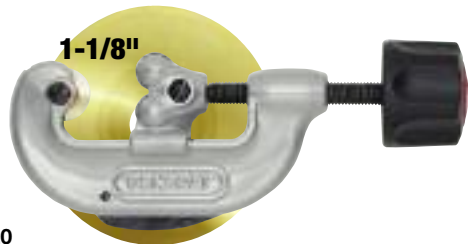

120

TUBING CUTTER

- Newly redesigned contoured shape comfort grip design.
- Bearing tool steel cutter wheel.
- Wide hardened flared grooved rollers allow cuts close to a flared end to avoid tube replacement in existing installations.
- Full sized fold out reamer with double cutting edges.

- Cuts copper, aluminum, brass, thin wall tubing and stainless steel.
- Large knob with a covered extra cutter wheel storage space.
- Replaceable cutting wheels: RW121/2, RW122.

UPC	NO.	CAPACITY
12003 8	120	1/8" to 1-1/8" (3mm- 30mm)



126

PIPE AND TUBING CUTTER

- General's best quality tubing and pipe cutter is designed to meet the demanding needs of the professional.
- Quick Release Button to speed use
- Capacity 1/4" - 2-5/8" (6 - 67mm)
- For cutting copper, aluminum, thin wall tubing, iron and PVC.
- Heavy Duty Construction for Tube or Pipe.
- Four rollers to accommodate multiple pipe sizes and prevent spiraling.

- Removable Machinists Reamer to easily deburr pipe.
- Quick Open and Close Mechanism to speed use.
- Extra Wheel Storage available in handle.
- Uses Standard General Tools Cutting Wheels #RW122 or #RW121.

UPC	NO.	CAPACITY
12017 5	126	2-5/8" (67mm) copper 1-1/4" (32mm) iron



127

IRON PIPE CUTTER

- All of the best features of General's No. 126 Pipe and Tubing Cutter and more.
- Large hardened flare groove rollers allow you to cut close to the flared ends of pipe or tubing.
- Deburrer has positive lock with two cutting edges.

- Solid frame for greater strength.
- Equipped with RW122 heavy-duty cutting wheel for iron, copper, stainless steel, and PVC pipe.
- Hardened Acme thread for greater strength.
- Replaceable cutting wheels: RW121/2, RW122.

UPC	NO.	CAPACITY
12020 5	127	2-5/8" (67mm)

Mini Tubing Cutters



- A mini must work in locations where standard cutters don't fit. Our new mini cutters work in tighter locations that the Pro and DIY'er encounter. We call it Spin Radius.
- A mini must be comfortable to spin to avoid hand fatigue. We've designed in contoured finger grip locations to increase comfort, working torque and speed.

- We added a large fluted, easy turning, adjusting knob, fine threaded feed screw and unique tracking rail system, to ensure reliable, smooth, friction free operation and greater torque.
- Adding our standard full sized bearing tool steel cutter to every General Mini makes our Pro Series our best ever.

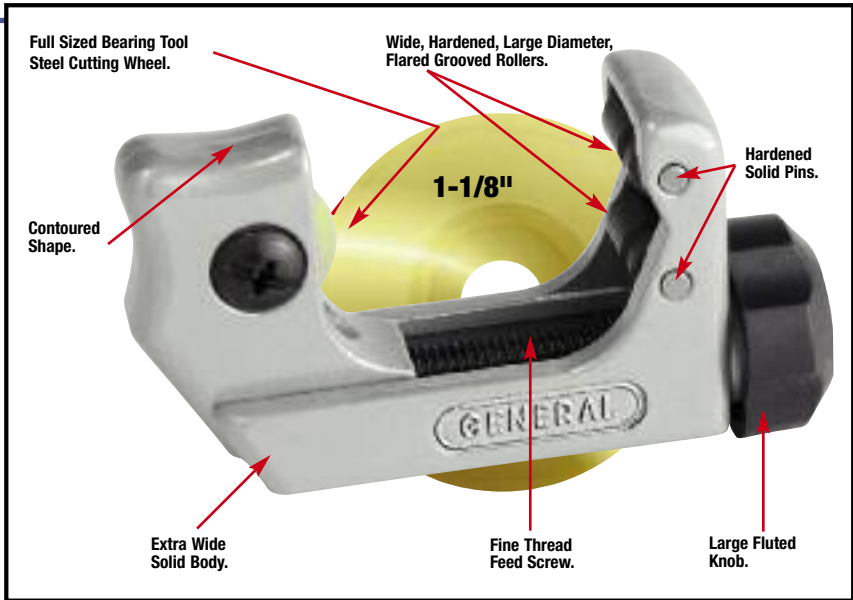

124

SUPER MINI TUBING CUTTER

- Comfort grip design for easy turning.
- Full size bearing tool steel cutter wheel.
- Large fluted adjusting knob for greater torque.
- Cuts copper, aluminum, brass, thin wall tubing and stainless steel.
- Wide hardened flared grooved rollers allows true cuts close to flared end tubing to avoid tube replacement in existing installations.

- Replaceable cutting wheel, RW121/2.

UPC	NO.	CAPACITY
01240 1	124	1/8" to 1-1/8" (3mm - 30mm)

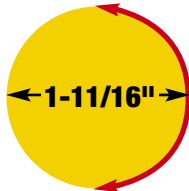

1-11/16" SWING RADIUS AT MAX CAPACITY

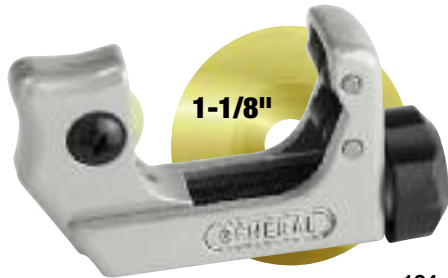

124

MINI TUBING CUTTER

- Comfort grip design for easy turning.
- Full size bearing tool steel cutter wheel.
- Large fluted adjusting knob for greater torque.
- Cuts copper, aluminum, brass, thin wall tubing and stainless steel.
- Wide hardened flared grooved rollers allows true cuts close to flared end tubing to avoid tube replacement in existing installations.

- Replaceable cutting wheel, RW121/2.

UPC	NO.	CAPACITY
12032 8	129X	1/8" to 7/8" (3mm - 22mm)

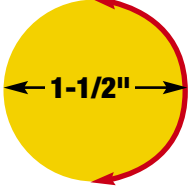

1-1/2" SWING RADIUS AT MAX CAPACITY



129X

MICRO TUBING CUTTER

- Comfort grip design for easy turning.
- Full size bearing tool steel cutter wheel.
- Large fluted adjusting knob for greater torque.
- Cuts copper, aluminum, brass, thin wall tubing and stainless steel.
- Wide hardened flared grooved rollers allows true cuts close to flared end tubing to avoid tube replacement in existing installations.

- Replaceable cutting wheel, RW121/2.

UPC	NO.	CAPACITY
12009 0	123R	1/8" to 5/8" (3mm - 15mm)

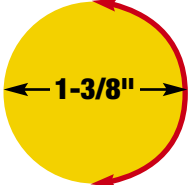

1-3/8" SWING RADIUS AT MAX CAPACITY



123R

PLUMBING TOOLS

Tubing Cutters

GENERAL®

General's full range of cutters makes the job easier to do for the professional plumber as well as the do-it-yourselfer. Each of our cutters produces cuts on copper, aluminum and thin wall tubing. Our 126 and

127 cutters are perfect for cutting iron pipe, tubing and PVC. Sizes range from 1/8" to 2-5/8" O.D. capacity. RW122 gold standard replacement cutter wheel fits no's. 1240, 120, 1209, 125, 1259, 126 & 127 cutters.

PLUMBING



125

HEAVY DUTY CUTTER

- Newly redesigned comfort grip for heavy-duty and industrial applications.
- Bearing tool steel cutter wheel.
- Wider, hardened flared grooved rollers allow cuts close to a flared end to avoid tube replacement in existing installations.
- Full size fold-out reamer.
- Cuts copper, aluminum, brass, thin wall tubing and stainless steel.

- Oversize knob for additional leverage.
- Spare cutting wheel storage position in handle.
- Replaceable cutting wheels: RW121/2, RW122.

UPC	NO.	CAPACITY
12015 1	125	1/4" to 1-5/8" (6mm- 41mm)



128

ENCLOSED FEED CUTTER

- General's finest professional quality cutter.
- Feed is enclosed to keep tool size consistent for work in confined spaces.
- Enclosed threads seal out dirt for long life.
- Wide hardened flared grooved rollers allow true cuts close to flared end tubing to avoid tube replacement in existing installations.
- Cuts copper, aluminum, brass, thin wall tubing and stainless steel.

- Hardened steel retractable reamer.
- Conforms to government specifications GGG-C-771d.
- Replaceable bearing tool steel cutter wheel, RW121/2 (included).

UPC	NO.	CAPACITY
12018 2	128	1/8" to 1-1/8" (3mm- 30mm)



133

E•Z™ RATCHET TUBING CUTTER

- Ratcheting action rotates the cutter around the tube allowing a standard size cutter to be used in close quarter applications.
- Longer handle requires less effort to rotate cutter reducing hand fatigue.
- Wide hardened flared grooved rollers allow true cuts close to flared end tubing to avoid tube replacement in existing installations.

- Cuts copper, aluminum, brass, thin wall tubing and stainless steel.
- Spare cutting wheel supplied in handle.
- Replaceable bearing tool steel cutting wheel, RW121/2.

UPC	NO.	CAPACITY
13300 7	133	5/16" to 1-1/8" (8mm - 30mm)

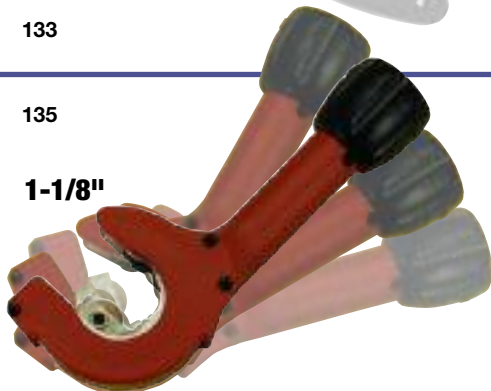

135

E•Z™ RATCHET II TUBE AND PIPE CUTTER

- Cuts without rotating tool completely around tube or pipe.
- Exclusive "One-Hand" operation.
- Ratchets in 5° increments while cutting 360° around tube.
- Large cutting diameter 1/8" to 1-1/8" (3mm-28mm).

- Cuts copper, brass, aluminum, stainless steel, PVC and thin wall conduit.
- Replaceable cutting wheels: RW135/2.

UPC	NO.	CAPACITY
01350 7	135	1/8" to 1-1/8" (3mm-28mm)
01351 4	RW135/2	Replacement Wheel (2)

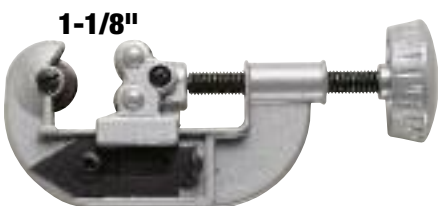

1209

CLASSIC STANDARD TUBING CUTTER

- For cutting copper, aluminum, brass and thin wall tubing in tight or hard-to-reach places.
- Large knob for added torque.
- Hardened flare grooved rollers.

- Retractable tool steel reamer.
- Replaceable cutting wheel: RW121/2.

UPC	NO.	CAPACITY
01209 8	1209	1/8" to 1-1/8" (3mm- 30mm)



PLUMBING TOOLS Cutting Tools



General's PVC Cutters are used for cutting PVC, PE and ABS pipe. All-metal construction allows for greater durability. Ergonomically designed handle allows for comfort and control. The hose and tubing

cutter cuts flexible rubber, PVC, ABS and Polyethylene tubing. The PVC Saw has a smooth, fast cutting blade for PVC and wood. Its high impact plastic handle can be pivoted and locked into multiple positions.

PLUMBING

CLASSIC HEAVY DUTY TUBING CUTTER

- Designed for heavy duty and industrial applications.
- Flared grooved rollers.
- For cutting copper, aluminum, brass and thin wall tubing.

- Double retractable tool steel reamer.
- Replaceable bearing tool steel cutting wheels available: RW121/2, RW122.

UPC	NO.	CAPACITY
01259 3	1259	1/4" to 1-1/2" (6mm- 37mm)

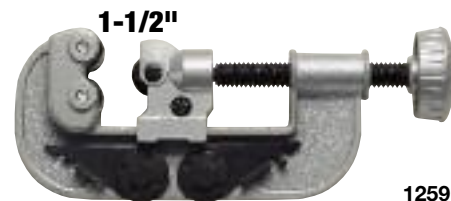

1259

CLASSIC MINI TUBING CUTTER

- For cutting copper, aluminum, brass and thin wall tubing in tight or hard-to-reach places.
- Large knob for added torque.
- Hardened flare grooved rollers.
- Replaceable cutting wheel: RW121/2.

UPC	NO.	CAPACITY
12028 1	129	1/8" to 7/8" (3mm - 22mm)

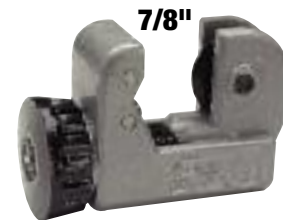

129

TRIGGER ACTION PLASTIC PIPE & HOSE CUTTER

- For cutting PVC, CPVC, Polyethylene, PEX, ABS.
- Easily fits into tight spaces.
- Quick blade replacement.

UPC	NO.	CAPACITY
01170 1	117	1-5/8" (42mm)
01171 8	117BG	Replacement Blade

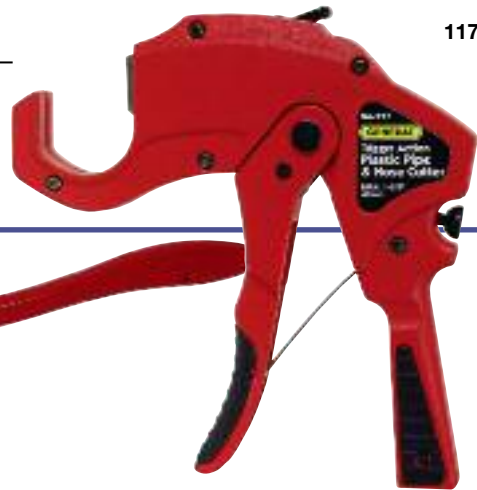

117

PVC RATCHET CUTTER

- For repeated heavy-duty cutting.
- Cuts hose, PVC, CPVC, polyethylene, PEX and ABS up to 2".
- Ratchet action for easy cutting.
- High carbon steel blade provides longer sharpness and clean cuts.
- Aluminum body is lighter and corrosion resistant.
- Safety locking clasp.

UPC	NO.	CAPACITY	LENGTH
01181 7	118	up to 2" (50mm)	17" (425mm)
01180 0	118BG	Replacement Blade	



118

ONE-HANDED PLASTIC PIPE & HOSE CUTTER

- For cutting PVC, CPVC, Polyethylene, PEX and ABS tubing.
- One-handed Operation.
- Quick-Blade Reset.
- Ratchet system holds blade in place while you adjust your grip to increase pressure.
- High carbon steel blade maintains sharpness and resists chipping.

- Handle locking strap for safe storage.
- Exclusive, easy replaceable blade feature.
- Ergonomically designed handle for comfort.
- Replacement Blade, No.119BG.

UPC	NO.	CAPACITY	LENGTH
31173 3	119	1/8" to 1-5/8"	8-1/4" (210mm)
01194 7	119BG	Replacement Blade	



119

ONE-HANDED PVC/HOSE CUTTER

- For cutting PVC, PE, PEX, ABS pipe.
- Professional quality, all-metal construction for greater durability.
- Ratcheting action for easy cutting.
- High carbon steel blade provides longer sharpness and clean cuts.
- Handle locks for safety.

- Ergonomically designed handle for comfort.
- | UPC | NO. | CAPACITY | LENGTH |
|---------|--------|---------------------|----------------|
| 01191 6 | 1191 | up to 1-5/8" (40mm) | 9-1/8" (231mm) |
| 11910 0 | 1191BG | Replacement Blade | |



1191



Cutting/Bending

General's PVC Cutters are used for cutting PVC, PE and ABS pipe. All-metal construction allows for greater durability. Ergonomically designed handle allows for comfort and control. The hose and tubing

cutter cuts flexible rubber, PVC, ABS and Polyethylene tubing. The PVC Saw has a smooth, fast cutting blade for PVC and wood. Its high impact plastic handle can be pivoted and locked into multiple positions.

PLUMBING



HOSE & TUBING CUTTER

- Cuts flexible rubber, PVC, ABS & polyethylene tubing.
- Long handles provide added leverage for easy cuts.
- Curved holder supports hose for square cuts.
- Replaceable steel blade.
- Capacities: rubber hose 2", polyethylene and ABS pipe 1", PVC pipe 1".

UPC	NO.	CAPACITY
01150 3	115	1" to 2" (25mm - 50mm)
LENGTH		
		9-1/2" (241mm)
11500 3	115B	Replacement Blade



PVC PIPE CABLE SAW

- For cutting PVC pipe in confined work areas.
- 24" stainless steel serrated cutting cable.
- Easily cuts pipe up to 8" in diameter.
- Comfort grip handles.

UPC	NO.	CAPACITY
08580 1	858	8" dia. (200mm)



PVC SAW/PVC SAW BLADE

- Smooth, fast cutting blade for PVC and wood.
- High impact plastic handle is grooved so that blade can be pivoted and locked into multiple positions.
- Overall length is 19" (483mm).

UPC	NO.
22062 2	859

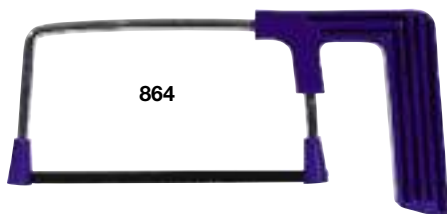

JUNIOR HACKSAW

- Handy cutting tool for hobbyists, do-it-yourselfers and professionals.
- Ergonomically designed with a comfortable high-impact plastic handle.
- 6" (150mm) replaceable heat treated blade for cutting metal.
- Sturdy tubular frame.

- Reversible blade for push or pull cutting.
- No. 864B, set of 6 replacement blades: 3 wood and 3 metal are available.

UPC	NO.
43067 0	864
43070 0	864B Set of 6 Blades



COMPOUND TUBING BENDER

- Will bend copper, brass, thin wall tubing, aluminum, soft wire and rods.
- 180° bends in a single action.
- Bender has calibrated angle markings from 0° to 180° for making accurate left, right and offset bends.
- Bends 4 sizes.

- Ergonomically designed handles for greater comfort.
- Durable die-cast alloy construction.
- Extra-long handle for greater leverage.

UPC	NO.	CAPACITY
14019 7	153	3/16" (5mm), 1/4" (6mm), 5/16" (8mm), 3/8" (10mm)



PLUMBING TOOLS

Bending/Flaring



General's flaring tools are essential for setting up or repairing flared tubing installations. Accurately flare copper, aluminum and thin wall tubing for leak free connections.

Each flaring tool forms 45° flares in seven popular sizes. Made of rust resistant plated steel bars. Tubing benders will bend copper, brass, thin wall tubing, aluminum, soft wire and rods.

TUBING BENDERS

- These tools eliminate crimping and collapsing of copper and other thin wall tubing. Made of oil hardened and tempered spring steel.
- Our tubing bender set contains one each of the sizes listed below, packaged in a display box.
- Available in individual sizes.

UPC	NO.	TUBE SIZE OUTSIDE DIA.
11009 1	S106	1/4", 5/16", 3/8", 7/16", 1/2", 5/8"

UPC	NO.	TUBE SIZE OUTSIDE DIA.	LENGTH
11003 9	100-1/4	1/4"	10-1/2"
11006 0	100-5/16	5/16"	10-1/2"
11018 3	100-3/8	3/8"	10-1/2"
11024 4	100-7/16	7/16"	10-3/8"
11012 1	100-1/2	1/2"	11-3/4"
11021 3	100-5/8	5/8"	11-3/4"
11015 2	100-3/4	3/4"	11-3/4"
11022 0	100-7/8	7/8"	11-3/4"

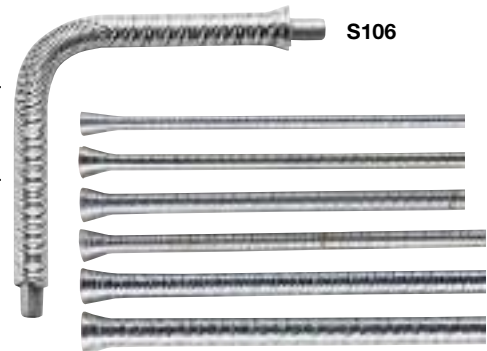

PLUMBING

DOUBLE FLARING TOOL

- Specially designed to double flare tubing for high pressure applications in automotive, air conditioning and refrigeration.
- Accurately single or double flares copper, aluminum and thin wall tubing for leak free connections.
- Quick opening plated steel bars for easy insertion and removal of tubing.

- Plated steel yoke and hardened steel bars for accurate flaring.
- Double flare inserts are case hardened steel.
- All parts have rust resistant finish.
- Portable storage case.

UPC	NO.	CAPACITY
14015 9	157	3/16", 1/4", 5/16" 3/8", 7/16", 1/2", 5/8"



PLIER FLARING TOOL

- All-steel construction.
- Freewheeling cone self centers accurately over tubing.
- Quick release allows insertion and removal of tubing easily.
- Quick release plier action handles hold tubing securely while flaring.

- Can be used in confined areas.
- Industrial quality.
- Vinyl handles for greater comfort.

UPC	NO.	CAPACITY
14022 7	152	3/16", 1/4", 5/16", 3/8", 1/2", 5/8"

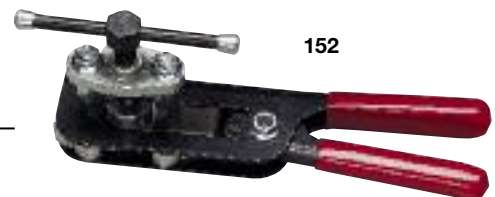

FLARING TOOLS

- High quality tool moderately priced.
- Screw yoke slips quickly over bars without removing heavy-duty wing nuts.
- Yokes have a freewheeling 45° plated cone for faster, smoother flaring and greater strength in flaring copper, aluminum, brass and thin wall tubing.
- Large heavy-duty hardened feed thread for durability.
- Long sliding T-handle provides maximum leverage.

- Quick opening plated bars for easy insertion and removal of tubing.
- Size individually marked on bars.
- Extra long bars to fit in vice, for easier flaring.
- No. 155 has a steel yoke and hardened bars.
- No. 151 has a cast iron yoke.

UPC	NO.	CAPACITY
14009 8	155	3/16", 1/4", 5/16" (Industrial) 3/8", 7/16", 1/2", 5/8"
14008 1	151	3/16", 1/4", 5/16", (Standard) 3/8", 7/16", 1/2", 5/8"

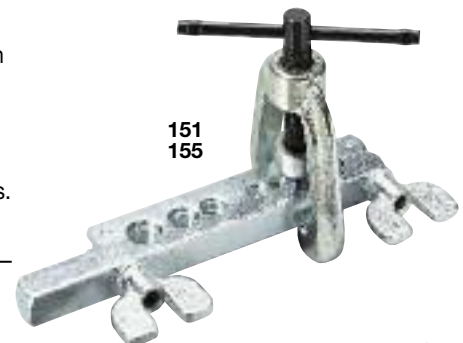

T-HANDLE REAMER

- Made of hardened and tempered tool steel with precision ground cutting edges.
- T-handle provides leverage for easier reaming.

UPC	NO.	CAPACITY
13003 7	130	1/8" to 3/8" (3mm - 10mm) 5-3/4" (146mm)



130

Reamers/Deburring

General offers a wide selection of reamers and deburring tools to plumbers, auto mechanics, steam-fitters, metal workers and mechanics. All of General's reamers are precision hardened with

ground cutting edges for durability. Reamers are used for removing burrs from cut pipe, tubing and conduit as well as for enlarging and counter-sinking holes in sheet metal, plastic and other material.

PLUMBING



131

SCREWDRIVER HANDLE REAMER

- General's easy-to-use reamer is perfect for in-home plumbing.
- Fluted plastic handle.
- Hardened and ground tempered steel.

UPC	NO.	CAPACITY	LENGTH
13006 8	131	3/8" (10mm)	6-1/2" (165mm)



810131

1/8" TO 5/8" X 3-1/2" ULTRATECH TAPERED REAMER

- Easy-to-use reamer is perfect for plumbing, countersinking holes or deburring cut pipe, tubing or conduit.
- Precision hardened with ground cutting edges for durability.
- Precision engineered 800 Series Versa-Grip™ handle for maximum performance.

- Handle length: 4-1/2" (113mm), Blade length: 4" (102mm), OAL: 8-1/2" (216mm).

UPC	NO.	PKG.
81020 5	810131	Carded



134

INNER/OUTER REAMER

- Inner/Outer Reamer will work on steel, iron, copper and PVC.
- Zinc die-cast body.
- Capacity 1-1/2" diameter (12.7mm).
- Grooved outer body gives you an easy grip.

- Internal and external reamers are made of heat treated high carbon steel.

UPC	NO.	CAPACITY
22077 6	134	1-1/2" (38mm)



196

HAND REAMER AND COUNTERSINK

- Handy tool for countersinking or deburring small jobs.
- The 3/4" five-flute tool steel cutter makes fast work of deburring. Deburring plastic, copper, iron pipe and sheet metal.

- Heavy-duty, ergonomically designed handle.

UPC	NO.	CAPACITY	LENGTH
23054 6	196	3/4" (19mm)	5-1/8" (130mm)

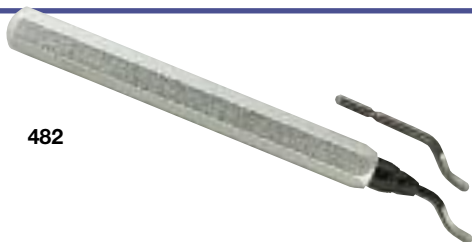

482

SWIVEL HEAD DEBURRING TOOL

- Professional quality and performance of higher price deburring tools.
- Two interchangeable blades.

UPC	NO.	HANDLE LENGTH
42324 5	482	5-1/8" (130mm)
42327 6	482A	Blade for steel, copper, aluminum and plastic.
42330 6	482B	Blade for brass and cast iron.



481

DEBURRING TOOL

- Pivot blade allows easy burr removal from iron pipe, copper and PVC tubing.
- Includes 1 replacement blade in storage handle.
- High impact plastic for durability.
- Replacement blades 482A & B are available.

UPC	NO.	HANDLE LENGTH
00481 9	481	5" (127mm)



484

DEBURRING KIT

- 4-piece swivel head deburring tool kit.
- 4 different blades, easily identified by color.
- Green for aluminum, red for brass, blue for steel and yellow for plastic.
- 4-3/4" plastic handle with convenient pocket-clip.

- Packaged in a reusable plastic clamshell blister.

UPC	NO.
48401 7	484

Deburring/Cleaning Brushes



Deburring tools are used for removing burrs from cut pipe, tubing, conduit and PVC tubing. Swaging tools are an easy and economical method of joining copper tubing. The pipe and fitting brushes are

used for cleaning inside and outside diameters of tubing and fittings in preparation for solder when sweating pipes. By expanding the tube the need for coupling is eliminated.

SWIVEL HEAD DEBURRING TOOL

- Deburring tools are used for removing burrs from cut pipe, tubing, conduit and PVC tubing.
- Two interchangeable blades; one for steel, aluminum, copper and plastic, one for brass, cast iron and plastic.
- Accepts all industry standard blades.

- Spring-loaded **Speed-Chuck™** allows blade changes instantly.
- Additional blade and storage available in handle.
- Precision engineered 750 Series Versa-Grip™ handle for maximum performance.

UPC	NO.	PKG.
75971 9	75402	Carded



75402



9-PIECE SWIVEL HEAD DEBURRING KIT

- Deburring tools are used for removing burrs from cut pipe, tubing, conduit and PVC tubing.
- Spring-loaded **Speed-Chuck™** allows blade changes instantly.
- Nine interchangeable blades handle any deburring job.
- Kit contains:
 - 1 each blade for
 - steel
 - aluminum
 - copper
 - plastic
 - 1 each blades for
 - brass
 - cast iron
 - plastic
 - 1 each corner edge
 - triangle
 - square flat scrapers.

- Additional blade and storage in fitted zippered case.
- Precision engineered 750 Series Versa-Grip™ handle for maximum performance.

UPC	NO.	PKG.
75972 6	75409	Zippered Case/Boxed



75409

4-PIECE SWAGING TOOL SET

- An easy and economical method of joining copper tubing.
- Eliminates the need for coupling.
- Hex body prevents rolling and allows easy removal from tube.
- Heat treated alloy steel, plated to prevent rust.

UPC	NO.	SPECIFICATIONS
14018 0	154ST	Set of 4 Swaging Tools
SIZES:		
1/4", 3/8", 1/2", 5/8"		



154ST

6-IN-1 SWAGING TOOL

- Handy swaging tool expands tubing eliminating the need for couplings.
- Expands 6 tubing sizes: 3/16", 1/4", 5/16", 3/8", 1/2" and 5/8" O.D. tubing.

- Use with a flaring bar to hold tubing.

UPC	NO.	LENGTH
01545 7	1545	5-1/4" (133mm)



1545

4-IN-1 PLUMBING BRUSH

- 4-IN-1 brush cleans both the inside and outside of copper tubing in preparation for solder when sweating pipes.
- Cleans most popular 1/2" and 3/4" I.D. tube and 5/8" and 7/8" O.D. tube.

- Hardened steel brushes and polypropylene body for strength and durability.

UPC	NO.
01140 4	114



114

2-IN-1 PIPE & FITTING BRUSHES

- Cleans I.D. and O.D. of tubing and fittings.
- Long lasting steel bristles.
- Designed for comfortable use and easy storage.

UPC	NO.	CAPACITY
22075 2	110	1/2" (12mm)
22076 9	111	3/4" (19mm)



110
111



Cleaning Brushes/Pipe Wrenches

Cleaning brushes are used for cleaning the inside and outside of tubing and fittings in preparation for solder when sweating pipes. Basin Wrenches, with

their pivoting jaws and long handles, permits access to holding nuts behind basins. Spring-loaded jaws allow for one-handed ratcheting

PLUMBING



TUBE O.D. CLEANING BRUSHES

- Cleans pipe O.D. for a good solder joint.
- Fluted octagon shape provides a firm hand-grip and will not roll.
- Inserting tubing to the backstop insures correct cleaning length for a good solder joint.
- Each brush cleans 2 tube sizes.

UPC	NO.	CAPACITY
01131 2	1131	3/8" I.D. - 1/2" O.D. (9 - 12mm)
01132 9	1132	1/2" I.D. - 5/8" O.D. (13 - 16mm)
01133 6	1133	3/4" I.D. - 7/8" O.D. (19 - 22mm)



INSIDE DIAMETER FITTING & TUBE BRUSHES

- Cleans the inside of copper fittings in preparation for solder when sweating pipes.
- Two sizes 1/2" & 3/4" fits the most common copper tube fittings.

- Use with General Tools No. 1132 and No. 1133 to completely clean fittings and tube inside and out.

UPC	NO.	CAPACITY
01121 3	1121	1/2" (12mm)
01122 0	1122	3/4" (19mm)

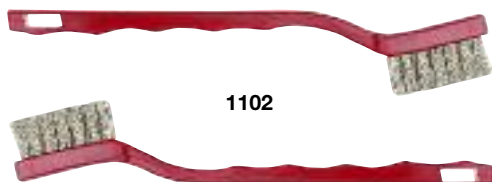

BRASS & STAINLESS STEEL CLEANING BRUSHES

- Handy utility brushes clean pipe, battery terminals, spark plugs and more.
- Brass brush is recommended for cleaning softer materials.

- Steel brush provides extra abrasion needed to clean pipe.

UPC	NO.	
01102 2	1102	(set of 2)

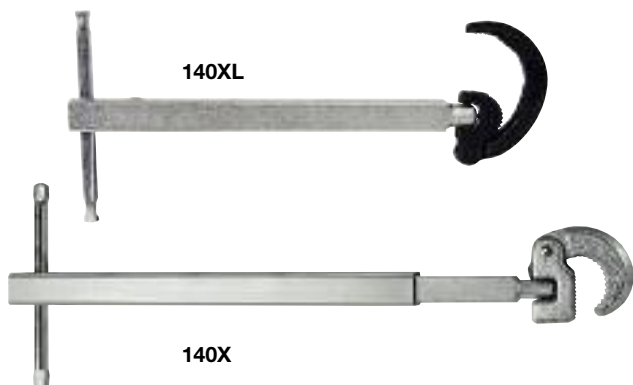

BASIN WRENCHES

- Pivoting jaws and long handle permits access to holding nuts behind basin.
- Sliding T-handle for working in confined areas.
- Spring loaded jaws for one-hand ratcheting.
- All handles are plated to prevent rust.
- 140X, 140XL extends from 11" (280mm) to 16" (400mm).
- The 140 is 11" long.

UPC	NO.	CAPACITY
13019 8	140	3/8" - 1-1/4" (10mm - 31mm)
13033 4	140X	3/8" - 1-1/4" (10mm - 31mm)
01401 6	140XL	1" - 2" (25mm - 50mm)

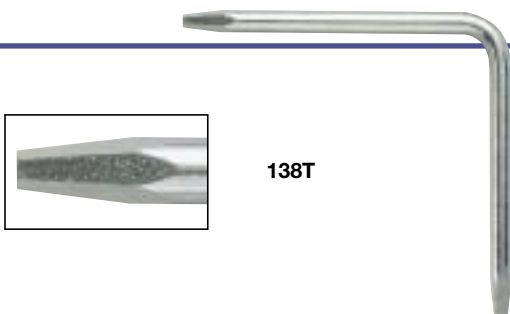

SEAT WRENCH

- Tapered seat wrenches for the removal of faucet seats.
- Hardened alloy steel.
- Plated to prevent rust.

UPC	NO.	SIZE
13016 7	138T	.230 - .400" Tapered



PLUMBING TOOLS Wrenches



Internal pipe wrenches are used for the removal of broken thread ends of pipe, pipe plugs and fittings. The nipple extractor is used to remove broken iron pipe nipples.

General's Undersink Drain Pliers, our exclusive designed pliers, fits all sink, drain, slip, trap and compression nuts, basin and sink lock nuts.

PROFESSIONAL INTERNAL PIPE WRENCHES & SETS

- For the removal of broken threaded ends of pipe, pipe plugs and fittings.
- Hex body can be used with a wrench.
- Pipe sizes are marked on each wrench.
- Heat treated alloy steel, plated to prevent rust.
- Size stamped on body.
- Conforms to gov. spec. GGG-W643b.

INDIVIDUAL SIZES

UPC	NO.	SPECIFICATIONS	LENGTH
13013 6	139A	3/8" (9.7mm)	3-3/4" (95.25mm)
13014 3	139B	1/2" (12mm)	3-3/4" (95.25mm)
13015 0	139C	3/4" (20mm)	3-3/4" (95.25mm)
13023 5	139D	1" (25mm)	3-3/4" (95.25mm)

SETS

13017 4	139ST	Set of 3 Internal Pipe Wrenches (139A, 139B, 139C)	
13026 6	139/4	Set of 4 Internal Pipe Wrenches (139A, 139B, 139C, 139D)	



139/4

UTILITY INTERNAL PIPE WRENCHES & SET

- For the removal of broken threaded ends of pipe, pipe plugs and fittings.
- Hex body can be used with a wrench.
- Pipe sizes are marked on each wrench.
- Heat treated alloy steel, plated to prevent rust.
- Size stamped on body.

UPC	NO.	SPECIFICATIONS
01390 3	1390	Set of 3 Internal Pipe Wrenches (1391, 1392, 1393)

INDIVIDUAL SIZES:

UPC	NO.	SPECIFICATIONS	LENGTH
01392 7	1392	1/2" (12mm)	3-3/4" (95.25mm)
01393 4	1393	3/4" (20mm)	3-3/4" (95.25mm)



1392

1393

5-PIECE IRON PIPE NIPPLE EXTRACTOR SET

- Used to remove broken iron pipe nipples by tapping them snugly into the broken pipe end; then turn counterclockwise with a wrench or socket that fits the hex end.
- Fits iron pipe nipples: NPT 1/8", 1/4", 3/8", 1/2" and 3/4".

- Plated to prevent rust.
- Tapered design for a snug fit and heat-treated for longer life.
- Size stamped on body.

UPC	NO.
01395 8	1395



1395



189

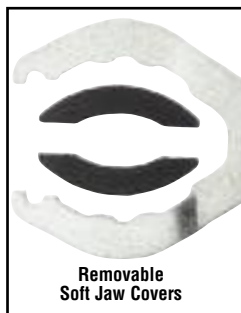

Removable Soft Jaw Covers

UNDERSINK DRAIN PLIER

- Our exclusive designed pliers fits all sink drain, slip, trap and compression nuts, basin and sink lock nuts.
- A true fits-everything drain pliers.
- The 3 position slip joint allows the pliers to work on all 1-1/4", 1-1/2" and 2" plastic and metal drain systems.
- Jaws expand to a huge 4" opening for large strainer nuts.

- Removable rubber jaw covers to protect plated nuts or pipes from damage.
- The textured handles provide a sure grip even with wet hands.
- Replaces jaw wrenches, slip nut and combination wrenches.
- Corrosion resistant chrome-plated.
- Can be used as oil filter pliers.

UPC	NO.	CAPACITY
18900 4	189	up to 4" (102mm) 10-1/4" (260mm)

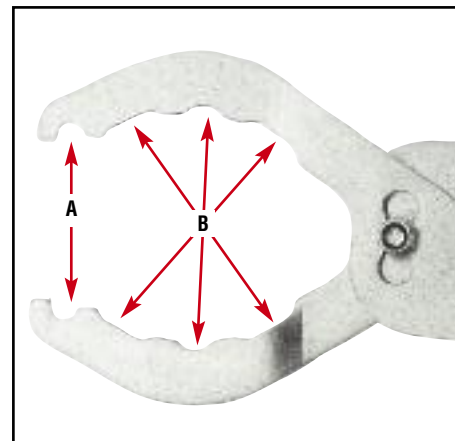

A. Fits Strainer Drain Nut Tabs.
B. Fits Tabs for Plastic Traps, Slip and Compression Nuts.

PLUMBING TOOLS
HAWK™ Wrench

**FREE
 DISPLAY**

**Order Item Number HWD and Recieve
 8 Hawk Wrenches and a FREE DISPLAY!**

- 1 – Display and Header – **FREE**
- 4 – 10" Wrenches – Regular Price (No. 1471)
- 4 – 14" Wrenches – Regular Price (No. 1472)



Long lasting, durable display can be restocked again and again! Sits on countertop or hangs on peg board.

HAWK™
**Ratchet Action
 Pipe Wrench**

PATENTED

Patent #7,096,764

2007
 RETAILERS
 AWARDS



E-Z Grip



E-Z Ratchet Action



E-Z Release

One-Handed Operation

Ergonomic design allows one-handed fitting, adjusting, torquing and removal

Self-Adjusting

Unlike a traditional pipe wrench, the HAWK automatically adjusts to different pipe sizes

Ratchet Operation

Spring-loaded jaw enables fast ratchet action

Shut-Off Key Wrench

The handle includes a valve shut-off key wrench

Patented 3-Point Jaw Grip

The patented 3-Point jaw design provides an extra-strong grip for increased torque

Quick Release

To disengage the HAWK, simply pull back on the convenient thumb trigger

GENERAL®

Order Hawk Wrenches Individually

Item No.	UPC	Wrench Size	Capacity Normal Pipe Diameter	Max Open Width Outside Pipe Diameter	Suit Max. Pipe Size Inch-BS Std Nominal Bore
1471	01471 9	10" / 250mm	1-1/2" - 40mm	1.77" - 45mm	1-1/4"
1472	01472 6	14" / 350mm	2" - 50mm	2.16" - 55mm	1-1/2"



Plumbing Pliers, which have chrome plated forged steel jaws, provide ample capacity for most pipes, nipples and fittings up to 2". Both pliers have removable jaw covers to protect plated nuts or pipes

from damage. Pipe wrenches have forged and ground jaws which provide ample capacity for most pipes, nipples and fittings up to 3". Both pipe wrenches have long handles for extra leverage and torquing.

ALUMINUM PIPE WRENCHES

- Professional quality.
- Adjustable steel jaw and long handle.
- Forged and ground jaws.
- Ergonomically designed handle.
- Almost half the weight of iron wrenches.
- Hang hole in handle.
- Body painted to prevent corrosion.

UPC	NO.	SIZE	CAPACITY
01482 5	1482	14" (350mm)	2" (50mm)
01483 2	1483	18" (450mm)	2-1/2" (65mm)
01484 9	1484	24" (600mm)	3" (80mm)



1483

IRON PIPE WRENCHES

- Professional quality.
- Forged and ground jaws.
- Ergonomically designed handle.
- Hang hole in handle.
- Body painted to prevent corrosion.
- Adjustable steel jaw and long handle.

UPC	NO.	SIZE	CAPACITY
01491 7	1491	10" (250mm)	1-1/2" (38mm)
01492 4	1492	14" (350mm)	2" (50mm)
01493 1	1493	18" (450mm)	2-1/2" (65mm)
01494 8	1494	24" (600mm)	3" (80mm)



1493

SOFT JAW PLUMBING PLIER

- Adjustable forged pliers with removable protective soft grip jaws.
- Remove soft jaws for standard work.
- Textured cushion grips provide a sure grip even with wet hands.
- Includes a spare set of soft jaws.
- Durable chrome plated forged steel jaws provide ample capacity for most pipes, nipples and fittings up to 2".
- 10" overall length provides extra torque.

UPC	NO.	CAPACITY	LENGTH
01590 7	159	2" (50mm)	10" (254mm)



Removable Soft Jaw Covers

159

STRAINER LOCK NUT WRENCH

- Adjustable jaw wrench is used to install or remove all strainer basket lock nuts.
- Extra long comfort grip handle allows access to lock nuts other wrenches can't reach.
- Non-rusting finish.
- Use with Model No. 183, Basket Strainer Wrench, to prevent slipping.

UPC	NO.	LENGTH
01860 1	186	12" (300mm)



186

PLUMBING TOOLS

Wrenches/Faucet



General's Stub Wrench removes PVC and CPVC broken plastic plumbing pipes and garden sprinkler risers. The adjustable wrench's jaws have a cutout for convenient locknut installation. The spud wrench removes

stubborn slip nuts, locknuts and spuds in tight places. The tub drain remover is used to install or remove tub drains with or without crossbars. Tap in for a snug fit then turn with a wrench or screwdriver.

PLUMBING



193

PLUG WRENCH

- Holds pop-up plugs and basket strainers in position.
- Prevents rotation of basket strainers during installation.
- Zinc plated to prevent rust.

UPC	NO.
22157 5	193

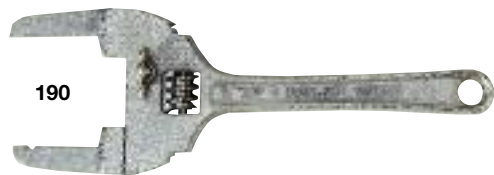

190

ADJUSTABLE WRENCH

- Jaws have a cutout for convenient locknut installation.
- Fits spudnuts, slip and locknuts and basket strainer nuts.
- Adjusts from 1" to 3" (25-75mm).
- Zinc plated to prevent rust.

UPC	NO.	LENGTH
22155 1	190	10-1/4" (260mm)



191

SPUD WRENCH

- Even in tight spaces, stubborn slip nuts, locknuts and spuds are no match for this tool.
- Handles three sizes of hex nuts: 1-3/4" (45mm), 2" (51mm), 2-1/2" (64mm).
- 1/2" lug turn and pivot hook.

- Stamped steel construction.
- Nickel plated to prevent rust.

UPC	NO.	LENGTH
22156 8	191	9-3/8" (238mm)



185

TUB DRAIN REMOVER

- Used to install or remove tub drains with or without crossbars. Tap in for a snug fit then turn with a wrench or large screwdriver.
- Double ended to fit most tub drains.
- Durable cast construction.

UPC	NO.
01850 2	185

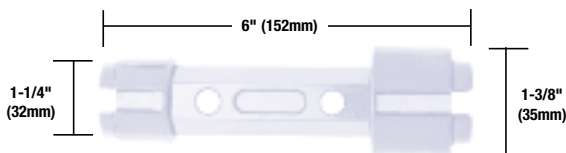

183

DOUBLE ENDED BASKET STRAINER WRENCH

- Holds strainer in position for easy installation while tightening the locking nut.
- Sliding handle provides a secure grip and needed torque.
- Two sizes to fit most basket strainers.
- Plated steel prevents rust.

UPC	NO.
01830 4	183





PLUMBING TOOLS

Wrenches/Faucet



The Garbage Disposal Wrench safely dislodges garbage disposal shredder plate jams. The Faucet Handle Puller can remove large or small faucet handles with ease. The shower valve wrench now

has a longer body length for access to recessed valve stems in tile covered walls. The stub wrench removes PVC and CPVC broken plastic plumbing pipes and garden sprinkler risers.

SHOWER VALVE WRENCHES

- Five-piece set comes with five double end wrenches, bar handle and a bar wire holder for easy storage.
- Sizes: 21/32 x 27/32; 29/32 x 31/32; 1-1/32 x 1-3/32; 1-5/32 x 1-9/32; 1-11/32 x 1-7/16.
- Longer length for access to recessed valve stems in tile covered walls.

UPC	NO.	TYPE	SIZES
22161 2	188	(Five piece set)	21/32" x 1-7/16"
01881 6	1881	Individual	21/32" x 27/32"
01882 3	1882	Individual	29/32" x 31/32"
01883 0	1883	Individual	1-1/32" x 1-3/32"



188

PLUMBING

STUB WRENCH

- Removes PVC and CPVC broken plastic plumbing and garden sprinkler risers.
- Serrated and tapered jaws are tapped into the riser for a tight fit for easy extraction.
- Comfort grip T-handle for added torque.

UPC	NO.	SIZES	LENGTH
01399 6	1399	1/2", 3/4" (12, 20mm)	7-3/4" (197mm)



1399

GARBAGE DISPOSAL WRENCH

- This universal wrench safely dislodges garbage disposal shredder plate jams.
- Swivel head design provides easy position on the shredder plate.
- The large flat surface cushion grip handle provides a comfortable grip.

UPC	NO.	LENGTH
01920 2	192	11.5" (292mm)

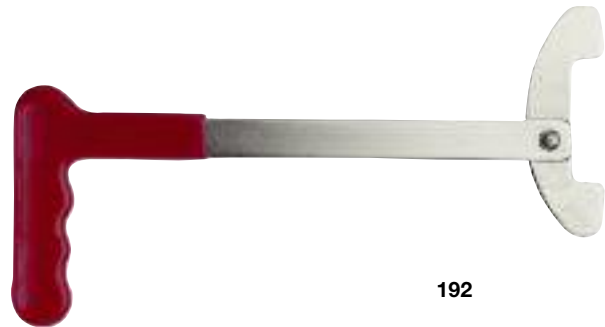

192

FAUCET HANDLE PULLER

- Removes large and small faucet handles with ease.
- Two adjustable fingers 4 inches long for a more secure grip.

UPC	NO.
22158 2	180

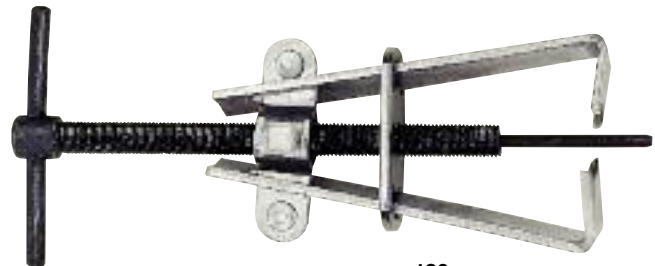

180

4-WAY FAUCET WRENCH

- One tool does the work of four individual wrenches.
- Sizes: 1/4", 9/32", 5/16", 11/32" internal square.
- Fits stopcocks, sillcocks and valves.
- Heat treated steel for greater strength.

UPC	NO.
22159 9	182

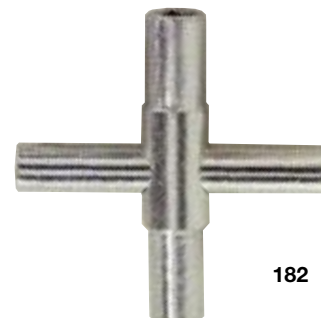

182

PLUMBING TOOLS

Wrenches/Faucet

GENERAL®

Strap wrenches provide a non-marring, slip-resistant grip. These wrenches are ideal for working on decorative finishes or irregular shapes.

The mini drain snake will clean out most problems of blocking sinks, bathtubs or toilets within 2 feet of the openings.

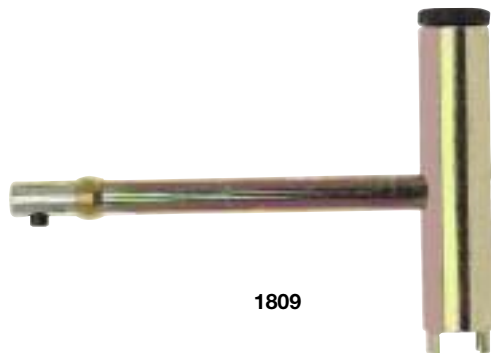

1809

STEM AND CARTRIDGE PULLER

- Works on plastic and brass cartridge stems for faucets, tubs and shower valves.
- For easy removal of Moen® style single lever faucet stem and cartridge and other plastic and cartridge sleeve.
- Works on plastic and brass faucets and shower valves.

UPC	NO.
01809 0	1809



1566

RUBBER STRAP WRENCH

- Fits any shape.
- Rubber strap for a non-marring, slip resistant grip.
- Tough thin strap works in tight spaces.
- Holds, loosens or tightens.

UPC	NO.	CAPACITY
01566 2	1566	6" O.D. (152mm)

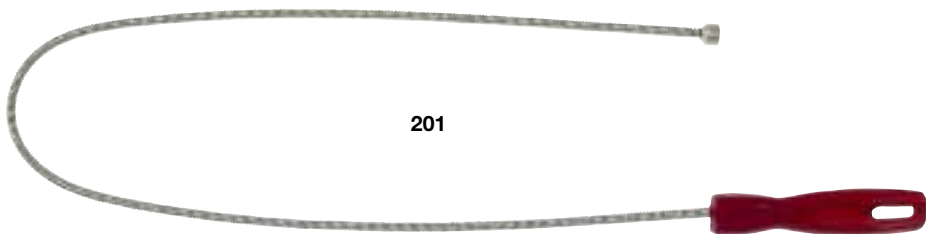

201

MINI-DRAIN SNAKE

- The Mini Snake will clean out most problems of blocked sinks, bathtubs or toilets within 2 feet of the opening.
- The sharp ended scraper will cut through most debris in openings 1/2" or larger.
- The flexible rod conforms to drain pipe without binding.
- The rod is plated to prevent rust and last for years.
- Useful for central vacuum clogs.

UPC	NO.	LENGTH
00201 3	201	24" (600mm)